

Geotechnical Engineering Design Report  
Proposed Mercer Island  
Center for the Arts Building  
Mercer Island, Washington

**Prepared for**  
Mercer Island Center for the Arts

**March 31, 2015**  
**19120-00**

Geotechnical Engineering Design Report

**Proposed Mercer Island Center for the Arts  
Building  
Mercer Island, Washington**

Prepared for  
**Mercer Island Center for the Arts**

March 31, 2015  
19120-00

Prepared by  
**Hart Crowser, Inc.**



**Matthew W. Veenstra, PE**  
Geotechnical Engineer



3/31/15

**David G. Winter, PE**  
Vice President

# Contents

PROJECT AND SITE DESCRIPTION	1
MAPPED GEOLOGY	2
SUBSURFACE CONDITIONS	2
<b>Subsurface Explorations</b>	<b>2</b>
<b>Soil Conditions</b>	<b>3</b>
Soil Unit 1: Fill and Colluvium Soils	3
Soil Unit 2: Fine-Grained Recessional Lacustrine Soils	3
Soil Unit 3: Fine-Grained Glacially Overridden Soils	3
<b>Groundwater Conditions</b>	<b>3</b>
MAPPED LANDSLIDE HAZARD REVIEW	4
GEOTECHNICAL ENGINEERING CONCLUSIONS AND RECOMMENDATIONS	4
<b>Earthquake Engineering</b>	<b>5</b>
Seismic Setting	5
Seismic Hazards	5
Building Code Seismic Parameters	5
<b>Excavation and Shoring Options</b>	<b>6</b>
<b>Temporary Shoring Recommendations</b>	<b>7</b>
Lateral Pressures	7
Soldier Pile Design	7
Lagging Design	8
Tieback Design	9
<b>Permanent Subgrade Walls</b>	<b>10</b>
Earth Pressures	10
Hydrostatic Groundwater Pressure	11
Seismic Earth Pressure on Walls	11
Surcharge Pressures on Walls	11
<b>Foundation Design Recommendations</b>	<b>11</b>
Axial Pile Capacity	11
Axial Pile Group Effects	12
Lateral Pile Capacity	12
Lateral Pile Group Effects	12
Lateral Earth Pressures for Pile Caps and Beams	13
Bearing Layer Depth for Piles	13

<b>GROUNDWATER CONTROL</b>	<b>14</b>
<b>Temporary Construction Dewatering</b>	<b>14</b>
<b>Permanent Drainage</b>	<b>15</b>
Walls Placed against Shoring	15
Slabs-on-Grade	15
Backfilled Walls	15
Final Site Drainage	16
Pavement Areas	16
<b>Pavement Design</b>	<b>16</b>
<b>GEOTECHNICAL RECOMMENDATIONS FOR CONSTRUCTION</b>	<b>16</b>
<b>Recommendations for Soldier Pile Installation</b>	<b>16</b>
<b>Recommendations for Lagging Installation</b>	<b>17</b>
<b>Recommendations for Tieback Installation</b>	<b>17</b>
<b>Recommendations for Tieback Testing</b>	<b>18</b>
Verification Tests	18
Proof Tests	19
<b>Shoring Monitoring Program</b>	<b>20</b>
<b>Augercast Pile Construction</b>	<b>21</b>
<b>Earthwork</b>	<b>22</b>
Site Preparation and Grading	22
Structural Fill	22
Use of On-Site Soil as Structural Fill	23
Temporary Cuts	23
<b>RECOMMENDATIONS FOR CONTINUING GEOTECHNICAL SERVICES</b>	<b>23</b>
<b>REFERENCES</b>	<b>24</b>
<b>TABLES</b>	
Table 1 – 2012 IBC Seismic Design Parameters	6
Table 2 - Axial Capacity Parameters for Drilled Soldier Piles	8
Table 3 – Recommended Temporary Lagging Thickness	9
Table 4 – Tentative Pullout Capacity for Temporary Tiebacks with Pressure-Grouted Bond Zone	9
Table 5 - Soil Equivalent Fluid Unit Weights for Walls Backfilled with Structural Fill	11
Table 6 - Axial Capacity Parameters for Augercast Piles	12
Table 7 – LPILE Soil Parameters	12
Table 8 – LPILE Reduction Factors for Lateral Pile Group Effects	12
Table 9 – Lateral Earth Pressure Determination for Pile Caps and Beams	13
Table 10 – Depth Top of Soil Unit 3 at Exploration Locations	13
Table 11 – Tieback Verification Test Schedule	19
Table 12 – Tieback Proof Test Schedule	19

## FIGURES

- 1 Vicinity Map
- 2 Site and Exploration Plan
- 3 Generalized Subsurface Cross Section A-A'
- 4 Generalized Subsurface Cross Section B-B'
- 5 Lateral Earth Pressures Temporary Shoring
- 6 Lateral Earth Pressures for Permanent Walls Constructed Against Shoring
- 7 Surcharge Pressures Determination of Lateral Pressure Acting on Adjacent Shoring

## APPENDIX A

### Field Exploration Methods and Analysis

## APPENDIX B

### Laboratory Testing Program

## APPENDIX C

### Historical Explorations

# Proposed Mercer Island Center for the Arts Building

Mercer Island, Washington

This report provides our geotechnical engineering recommendations for the proposed Mercer Island Center for the Arts building in Mercer Island, Washington.

Our scope of work was to:

- Collect and assess subsurface conditions from historical explorations;
- Drill seven borings from 21.5 to 51 feet deep;
- Prepare logs of the soil explorations;
- Assess groundwater conditions;
- Conduct engineering analysis; and
- Prepare this report.

We completed this work in general accordance with our contract dated February 5, 2015. This report is for the exclusive use of Mercer Island Center for the Arts and their design consultants for specific application to this project and site. We completed this work in accordance with generally accepted geotechnical engineering practices for the nature and conditions of the work completed in the same or similar localities, at the time the work was performed. We make no other warranty, express or implied.

## PROJECT AND SITE DESCRIPTION

The site vicinity map and exploration plan are shown on Figures 1 and 2.

The proposed building will be located on city-owned land adjacent to the northwest corner of the Mercerdale Park. The property consists of a relatively flat, mowed lawn area to the east and a wooded slope to the west.

The top of the wooded slope begins near 74th Place SE, about elevation 280 feet, and descends eastward down to about elevation 90 feet at the toe. Upslope from the building site, the slope gradient varies from about 20 percent to greater than 40 percent across the western half of the slope and the gradient varies from less than 5 percent to about 22 percent across the eastern half of the slope. The portion of the slope that was surveyed for this study (about 120 feet west of the toe) has average gradients of about 5 to 22 percent.

Slope vegetation is primarily Alder and Maple with occasional Douglas Fir and Western Red Cedar. The Alder and Maple are frequently bowed downhill which suggests possible downhill soil creep.

The eastern half of the site varies from about elevation 88 to 91 feet and primarily consists of landscaped grass lawn and paved walking paths. The northern portion of the building site, adjacent to SE 32nd Street, is partially occupied by asphalt pavement, a one-story building, and a concrete paved area. We understand that the eastern half of the site was filled about 48 years ago when a school building was planned, but never built (Shannon & Wilson 1985).

We understand that the building location, size, and ground floor elevation are subject to change. However, we have been provided two preliminary concepts, Concept A and Concept C. Concept A is oriented slightly farther from the slope than Concept C. This report assumes Concept C because it is the worst-case scenario from a geotechnical perspective. The building is expected to be two stories tall and have a roughly 28,000 square foot footprint. The finish floor elevation is expected to be between elevations 88 to 91 feet in both concepts. The building may be cut into the west slope and retained soil cuts could be on the order of 12 to 18 feet tall.

We understand that there is no new surface parking planned at this time, but there will be a new paved fire lane.

## MAPPED GEOLOGY

According to the Geologic Map of Mercer Island, Washington (Troost & Wisner 2006), the mapped geology in the vicinity of the building site includes Quaternary Vashon recessional lacustrine deposits overlain by landslide deposits and artificial fill. The encountered soils are consistent with the mapped geology.

Upslope from the site, the soils are mapped as Pre-Olympia fine-grained glacial deposits, overlain by pre-Fraser nonglacial deposits, overlain by Lawton Clay, overlain by Vashon advance outwash, overlain by Vashon subglacial till.

## SUBSURFACE CONDITIONS

### Subsurface Explorations

Subsurface exploration locations are shown on Figure 2 and generalized subsurface cross sections A-A' and B-B' are shown on Figures 3 and 4 respectively.

Our understanding of the subsurface conditions is based on current and historical explorations at the site and laboratory analysis of samples from the borings. On February 25 and 27, 2015, we completed seven borings, HC-1 to HC-7, to depths of 21.5 to 51.0 feet below ground surface (bgs). The exploration logs are provided in Appendix A. The results of laboratory tests are provided in Appendix B.

We also reviewed historical logs of explorations and laboratory results by Shannon & Wilson Inc. (1985). These included five soil borings, B-1 to B-5, drilled to depths of 24.5 to 39.5 feet bgs and seven test pits, TP-1 to TP-7, excavated to 10.5 to 13 feet bgs. Relevant explorations in the vicinity of the building site are SW-B-5 and SW-TP-1.

We also reviewed the historical logs of explorations and laboratory results by Hart Crowser & Associates, Inc. (1979) for the Farmers Insurance Group Building immediately north of the building site. Relevant explorations near the building site include boring HC-B-5.

Relevant historical exploration locations are shown on Figure 2 and the historical boring logs, test pit logs and laboratory results are provided in Appendix C.

## Soil Conditions

The interpreted soil conditions in the vicinity of the building site generally consists of three basic soil units:

### ***Soil Unit 1: Fill and Colluvium Soils***

Interpreted fill or colluvium soils were encountered in all of explorations done for this study as well as HC-B-5, SW-B-5, and SW-TP-1 and typically consisted of as much as 2 feet of silty gravel or silty sand typically overlaying medium stiff to stiff silt, silty clay, and clay to about 4 to 9 feet bgs. Boring HC-3 encountered loose sand to 9.5 feet bgs. Test pit SW-TP-1 encountered remnant topsoil from 5 to 6.5 feet bgs and boring HC-4 encountered remnant topsoil from about 5 to 5.5 feet bgs. This soil unit is generally not suitable for heavy foundation loads or large tieback loads.

### ***Soil Unit 2: Fine-Grained Recessional Lacustrine Soils***

This soil unit generally consists of normally consolidated soft to stiff silt, clayey silt, and clay soils with occasional loose to medium dense silty and gravelly sand layers. The consistency of this soil unit is variable and is not considered suitable for support of heavy loads or settlement-sensitive structures. This soil unit is generally not suitable for heavy foundation loads or large tieback loads.

### ***Soil Unit 3: Fine-Grained Glacially Overridden Soils***

This soil unit generally consists of stiff to hard clayey silt and clay soils with occasional slickensides and highly organic zones. The depth to the top of this unit varied from about 13 to 33 feet bgs but was typically encountered within about 25 feet bgs. We recommend that pile foundations and soldier piles bear within this soil unit.

## Groundwater Conditions

At the time of our visit, the ground surface was wet and soft across the site because the near-surface soils are typically fine-grained and poorly drained.

Borings HC-3, HC-4, and HC-7 encountered groundwater at about 20 feet bgs during drilling. However, most of the current and historical explorations did not encounter free water at the time of drilling/excavation but indicate groundwater levels within 1 to 2 feet bgs, suggesting excess water pressure within the relatively permeable (sandy) soil layers below ground surface (Shannon & Wilson 1985).



The regional groundwater table is deeper than the borings done for this project; however, perched groundwater within sandy soil layers and poorly draining near-surface soils can lead to local water within a couple feet of ground surface. Also, excavations into the hillside may encounter water seepage in sandy zones that can cause running or caving soils and reduced face stability.

Based on the observed and reported groundwater conditions, we recommend that drainage and waterproofing for walls and foundations be designed assuming the groundwater table is at the ground surface.

Note that water levels were measured at the times and under conditions stated on the boring logs. Fluctuations in the groundwater conditions may be caused by variations in rainfall, temperature, season, and other factors. Subsurface conditions interpreted from explorations at discrete locations on the site and the soil properties inferred from the field and laboratory tests, formed the basis of the geotechnical recommendations in this report. The nature and extent of variations between explorations may not become evident until additional explorations are performed or construction begins. If variations are encountered, it may be necessary to reevaluate the recommendations in this report.

## MAPPED LANDSLIDE HAZARD REVIEW

We reviewed the Mercer Island Landslide Hazard Assessment map (Troost & Wisner 2009) for the site location. The site is mapped as an identified land slide location and is partially within mapped landslide deposits. Upslope from the building site, the map identifies areas of historic slope failure. These include:

- Slopes steeper than 15 percent (3.7H:1V) intersecting a geologic contact of relatively permeable deposits over relatively impermeable deposits with groundwater seepage
- Areas of slope steeper than 40 percent (1.2H:1V) with a vertical relief of ten or more feet (Qualifications i, ii, iii, ix)

In our opinion, construction of this building will not increase or decrease the landslide hazard in this vicinity. There is a risk that if a landslide occurs upslope from the site, the resulting landslide debris could travel down the slope and impact the proposed building. It is outside the scope of this report to provide recommendations for the potential impacts on the proposed building caused by a landslide well upslope of the building site.

## GEOTECHNICAL ENGINEERING CONCLUSIONS AND RECOMMENDATIONS

Our recommendations are based on our understanding of the project and the subsurface conditions interpreted from explorations at and near the site by Hart Crowser and others. If the nature or location of the facilities is different than we have assumed, we should be notified so we can review, change, and/or confirm our recommendations.

## Earthquake Engineering

### ***Seismic Setting***

The seismicity of western Washington is dominated by the Cascadia Subduction Zone (CSZ), where the offshore Juan de Fuca plate subducts beneath the continental North American plate. Three main types of earthquakes are typically associated with subduction zone environments: crustal, intraplate, and interplate earthquakes. Seismic records in the Puget Sound area clearly indicate a distinct shallow zone of crustal seismicity, the Seattle Fault, which may have surficial expressions and can extend to depths of 25 to 30 km. A deeper zone is associated with the subducting Juan de Fuca plate and produces intraplate earthquakes at depths of 40 to 70 km beneath the Puget Sound region (e.g., the 1949, 1965, and 2001 earthquakes) and interplate earthquakes at shallow depths near the Washington coast (e.g., the 1700 earthquake with an approximate magnitude of 9.0).

### ***Seismic Hazards***

- **Liquefaction induced subsidence.** There appear to be isolated zones of medium dense, wet sand beneath the building site that could lose strength during or after an earthquake. However, because significant free water and a continuous sand layer was not encountered, it is our opinion that the risk of liquefaction-induced subsidence is low.
- **Slope stability.** The slope within 120 feet or so of the Concept C building (about 14 to 18 percent slope) site is not steep enough to pose a seismic slope stability risk. Further upslope there are mapped historic failures, steep slopes, and groundwater seepage that present a risk of future landslides which could impact the proposed building. An earthquake would increase the risk of a landslide occurring.
- **Fault rupture.** The mapped northernmost splay of the Seattle Fault is about 0.3 miles south of the site. There is a remote potential for surface rupture at the site from a new splay of the Seattle Fault. However, this hazard is very low based on the Seattle Fault's 3,000-year recurrence interval, the many possible locations for surface rupture, and the likelihood that the fault would not produce surface rupture at this location.

### ***Building Code Seismic Parameters***

Based on the measured and extrapolated average SPT blowcount in the top 100 feet of soil, it is our opinion that the site class is best characterized as D.

Table 1 provides 2012 International Building Code (IBC) seismic design parameters for the site and the recommended soil Site Class. The parameters were obtained from the USGS US Seismic Design Maps web application (<http://earthquake.usgs.gov/designmaps/us/application.php>) accessed March 2015.

Table 1 – 2012 IBC Seismic Design Parameters

Parameter	Value
Latitude	47.58151
Longitude	-122.23552
Site Class	D
PGA	0.572 g
S <sub>s</sub>	1.388 g
S <sub>1</sub>	0.538 g
F <sub>a</sub>	1.0
F <sub>v</sub>	1.5

## Excavation and Shoring Options

We understand that the location of the building is subject to change. If the building is situated west of the toe of the existing slope, then shoring and/or regrading will be required to maintain soil cut and slope stability. We recommend considering the following options:

**Option 1.** Locate the building beyond the toe of the slope. The advantage of this option is that shoring would not need to be designed or built. The building would also not need to accommodate the relatively large static and seismic loads of the retained soil.

**Option 2.** Locate the building within the existing slope and retain the cut using temporary shoring; also, place the permanent building wall directly against the shoring so that the soil loads are transferred to the building structure. With this option, the building will need to be designed for the static and seismic earth pressures of the retained sloping soils.

**Option 3a.** Locate the building within the existing slope and retain the soil cut using permanent shoring that is not structurally connected to the building structure. With this option, the building will not need to be designed for the static or seismic earth pressures from the retained slope. The shoring will need to be designed as a permanent structure, which is more expensive than temporary shoring.

**Option 3b.** Locate the building about 4 feet interior of the temporary shoring wall. The gap between the shoring wall and permanent wall can be backfilled with gravel. The shoring tiebacks would be de-stressed as the gravel backfill is placed. The permanent building wall can then be designed for a conventional triangular active earth pressure distribution.

**Option 4.** Locate the building within the existing slope, but regrade and move the toe of the slope west, outside the building footprint. This option would not require temporary shoring and the building would not need to be designed to accommodate retained earth pressures. A permanent slope would need to be designed to be no steeper than 2H:1V.

## Temporary Shoring Recommendations

Shoring should be designed by a professional structural engineer registered in the State of Washington. We recommend that we be given the opportunity to review the geotechnical aspects of the shoring design before construction. It is not the purpose of this report to provide specific criteria for the contractor's construction means and methods. The shoring contractor should be responsible for verifying actual ground conditions and determining the construction methods and procedures needed to install an appropriate shoring system.

This section addresses a temporary shoring wall built into the existing slope at the west side of the Concept C building location. Assuming an excavation down to elevation 88 feet, the slope cut could be on the order of 12 to 18 feet tall.

We did not do soil explorations along a substantial portion of the Concept C west building line, so we have assumed that the retained soils would primarily consist of Soil Unit 1 or 2.

### ***Lateral Pressures***

We expect that temporary shoring will consist of soldier piles and timber lagging with cantilevered and tied-back sections and that active earth pressures are applicable. Active earth pressures assume that the top of the shoring is allowed to deform on the order of 0.001 to 0.002 times the shoring height.

For cantilevered walls, we recommend a triangular earth pressure distribution. For tied-back walls, we recommend a trapezoidal earth pressure distribution. Our recommended earth pressures for temporary shoring are provided on Figure 5.

Timber lagging is expected to freely drain so that water does not build up behind the walls. Assuming a free-draining wall, the temporary shoring does not need to be designed for water pressure behind the wall.

Additional lateral pressures due to surcharge loads (e.g., buildings, footings, heavy equipment, large material stockpiles) should be calculated using methods shown on Figure 7. These loads would be added to the loads calculated for the shoring walls. We recommend Hart Crowser review or calculate the estimated surcharge loads when surcharge loads, footprints, and foundation plans of adjacent structures are available.

### ***Soldier Pile Design***

We make the following recommendations for soldier pile design:

- Use the axial pile capacity parameters in Table 2 to calculate the vertical capacity of the soldier piles. We recommend embedding piles at least 10 feet into the fine-grained glacially overridden soils (Soil Unit 3). Neglect the pile-side friction above the bottom of the excavation.

Table 2 - Axial Capacity Parameters for Drilled Soldier Piles

Soil Unit	Allowable Unit Side Capacity	Allowable Unit End Capacity
1 and 2	0.2 ksf	N/A
3	1.0 ksf	30 ksf

- Design soldier piles for bending using a uniform loading value equivalent to 80 percent of the design values and analyze for shear using total load.
- To design against kickout, compute the lateral resistance using the passive pressure on Figure 5 acting over two times the diameter of the concrete shaft section or the pile spacing, whichever is less.
- The embedded portion of the pile shaft should be at least 2 feet in diameter.

These recommendations assume proper installation of the soldier piles as discussed in the construction recommendations section of this report.

### ***Lagging Design***

Temporary lagging should be designed in accordance with FHWA GEC 4 (FHWA 1999), structural engineering guidelines, soil type, and local experience. Table 3 provides recommended lagging thicknesses based on the FHWA recommendations.

Based on our site investigation, we recommend using a Soil Type of “Competent.”

Table 3 – Recommended Temporary Lagging Thickness

Soil Type	Exposed Wall Height (feet)	Clear Span of Lagging (feet)					
		5	6	7	8	9	10
		Minimum Actual Thickness of Rough Cut Timber Lagging (inches)					
Competent <sup>1</sup>	25 and under	2	3	3	3	4	4
	Over 25 to 60	3	3	3	4	4	5
Difficult <sup>1</sup>	25 and under	3	3	3	4	4	5
	Over 25 to 60	3	3	4	4	5	5
Potentially Dangerous <sup>1</sup>	15 and under	3	3	4	5	See Note <sup>2</sup>	See Note <sup>2</sup>
	Over 15 to 25	3	4	5	6	See Note <sup>2</sup>	See Note <sup>2</sup>
	Over 25	4	5	6	See Note <sup>2</sup>	See Note <sup>2</sup>	See Note <sup>2</sup>

<sup>1</sup>Soil Type as defined in WSDOT Standard Specifications section 6-16.3(6)A

<sup>2</sup>For exposed wall heights exceeding the limits in Table 3, or where minimum rough cut lagging thickness is not provided, the Contractor should design the lagging in accordance structural engineering guidelines and local experience. Soldier pile and lagging shoring may not be appropriate in these cases.

### ***Tieback Design***

We recommend the tentative allowable tieback pullout values in Table 4 for a typical 6-inch-diameter drilled hole with a pressure-grouted bond zone. The allowable transfer load includes a recommended factor of safety of 2.0. The factor of safety should be confirmed by completing at least two successful verification tests in each soil type. Additionally, each tieback should be proof tested to 133 percent of the design load. Our recommended tieback testing program is provided in the construction recommendations section of this report. We recommend that the shoring contractor and/or designer determine a final design tieback pullout resistance based on their previous experience on Mercer Island, which must then be confirmed by field testing.

Table 4 – Tentative Pullout Capacity for Temporary Tiebacks with Pressure-Grouted Bond Zone

Soil Unit	Allowable Capacity
1 and 2	1 kip per foot
3	3 kip per foot

We make the following additional recommendations for tieback design:

- Do not install the bond zone within Soil Units 1 or 2, if possible.
- Tieback bond zones should be located outside of the no-load zone. The no-load zone is shown on Figure 5 as a zone bounded by a 60-degree line to the horizontal that starts at a distance of H/4 from the bottom of the excavation where H is the excavation height.
- Locate anchors at least three tieback diameters apart.

- Design anchor lengths so that they do not conflict with any underground support elements of adjacent structures.
- Identify existing facilities adjacent to the project site including buried utilities and foundations, as these may affect the location and the length of the anchors.
- Allow the contractor to select the tieback anchor material and the installation technique. The shoring contractor should be contractually responsible for the design of the tieback anchors, as tieback capacity is largely a function of the means and methods of installation. The selected installation method must be confirmed using verification and proof testing as discussed below.
- Hart Crowser should review the design for anchor locations, capacities, and related criteria prior to implementation.

## Permanent Subgrade Walls

This section addresses permanent walls built against temporary shoring that would retain cuts into the existing slope on the west side of the building. This section also addresses backfilled walls that are not connected to temporary shoring.

### ***Earth Pressures***

Permanent subsurface walls constructed adjacent to soldier pile shoring may be designed using the same earth pressure values and distribution that was used for shoring design. If there is a gap between the shoring and permanent walls then use a conventional active earth pressure for the backfill material. The earth pressure does not include surcharge loads such as loads from adjacent buildings; these must be calculated separately and added to get the total permanent lateral pressure.

Permanent walls that are backfilled and are not adjacent to shoring walls should be designed using a triangular earth pressure distribution. For typical granular fill soil, active and at-rest pressures may be determined using the equivalent fluid unit weights in Table 5. Note that the equivalent fluid density does not include any surface loading conditions or loading due to groundwater hydrostatic pressure; also, the ground surface behind the wall is assumed to be horizontal. Walls without drainage must be designed for full hydrostatic pressure.

The use of active and passive pressure is appropriate if the wall is allowed to yield a minimum 0.001 times the wall height. For a non-yielding wall, at-rest pressures should be used.

Table 5 - Soil Equivalent Fluid Unit Weights for Walls Backfilled with Structural Fill

Soil Type	Parameter	Value (pcf)
Structural Fill	Active Earth Pressure	35
	At-Rest Earth Pressure	55
	Passive Earth Pressure <sup>a</sup>	300

Notes:

a. Includes a factor of safety of 1.5.

### ***Hydrostatic Groundwater Pressure***

We recommend full height drainage for all walls and foundations in order to preclude water pressure loads against the walls or foundations.

### ***Seismic Earth Pressure on Walls***

For walls retaining the soil slope, use a seismic earth pressure increment of 13H psf. For wall retaining level backfill use a seismic earth pressure increment of 9H psf. These earth pressures assume Soil Units 1 or 2 are present behind the wall with an average soil backslope of 7H:1V (8 degrees). The seismic earth pressure is calculated using the 2012 IBC design hazard level (2/3 of the MCE) for the site.

Apply the seismic increments as a uniform pressure from the top to the bottom of the wall as shown on Figure 6.

### ***Surcharge Pressures on Walls***

The pressures shown on Figures 5 and 6 do not include surcharge loads due to buildings, footings, heavy equipment, large stockpiles, etc. These loads must be calculated separately, using the methods shown on Figure 7, or similar, and added to the pressures determined using Figures 5 and 6.

We recommend Hart Crowser that review or complete the estimated surcharge loads when surcharge loads, footprints, and foundation plans of adjacent structures are available.

## Foundation Design Recommendations

### ***Axial Pile Capacity***

We recommend pile foundations for the building because the upper soils are relatively weak and compressible and we expect that the building loads will be relatively high. In our opinion, the most suitable pile type is augercast piles because they typically offer the best combination of capacity and cost. Driven piles are not recommended because of potential noise issues and also ground vibrations that could adversely affect nearby slope stability.



Calculate the diameter and length of the piles using the allowable unit side and end capacities in Table 6. Do not include base capacity when calculating the total uplift capacity. Neglect side friction of the upper 5 feet of the shaft to accommodate potential soil disturbance. All piles should be embedded a minimum of 10 feet into Soil Unit 3.

Table 6 - Axial Capacity Parameters for Augercast Piles

Soil Unit	Allowable Unit Side Capacity	Allowable Unit End Capacity
1 and 2	0.2 ksf	Note recommended
3	1 ksf	35 ksf

### ***Axial Pile Group Effects***

To avoid axial group effects, we recommend a minimum center-to-center pile spacing of 3D, where D is the smallest pile diameter.

### ***Lateral Pile Capacity***

Lateral loads are resisted primarily by the horizontal bearing support of near-surface soils around the piles and pile caps. The lateral capacity of a pile depends on its length, stiffness in the direction of loading, proximity to other piles, and degree of fixity at the head, as well as on the engineering properties of the upper soils. The design lateral capacity of vertical piles will depend largely on the allowable lateral deflections of the piles.

Lateral pile analysis may be done using LPILE software using the soil parameters in Table 7.

Table 7 - LPILE Soil Parameters

Soil Unit	Soil Model	Effective Unit Weight (pcf)	Undrained Cohesion (psf)	Strain Factor, E50 (pci)
1 and 2	Soft Clay	110	600	Default
3	Stiff Clay w/o Free Water	120	4,000	Default

### ***Lateral Pile Group Effects***

Lateral group effects must be considered for pile spacings less than 5D, where D is the smallest pile diameter. We recommend the group reduction factors in Table 8 be used for LPILE analysis.

Table 8 - LPILE Reduction Factors for Lateral Pile Group Effects

Pile Center-to-Center Spacing (ft)	P-Multipliers, P <sub>m</sub>		
	Row 1	Row 2	Row 3 and higher
3D	0.8	0.4	0.3
5D	1.0	0.85	0.7

### ***Lateral Earth Pressures for Pile Caps and Beams***

Active and passive earth pressures act over the embedded portion of pile caps and grade beams. We recommend backfilling around pile caps and beams with structural fill. We recommend using the values in Table 9 to determine the lateral earth pressure for pile caps and beams. Neglect the upper 1 foot of soil resistance unless the soil surface is covered by pavement or slabs. Passive resistance assumes a safety factor of 1.5, which may be increased by 1/3 for short-term loads such as wind or earthquake.

Table 9 – Lateral Earth Pressure Determination for Pile Caps and Beams

Parameter	Soil Type	Value (pcf)
Active Earth Pressure	Structural Fill	35
Passive Earth Pressure	Structural Fill	300

Mobilization of passive pressure may be calculated from Figure 4-6 of ASCE 41-06 for varying degrees of movement as calculated iteratively using LPILE. Alternatively, full passive pressure may be used for movement of 0.05H, where H is the depth below ground surface to the bottom of the pile cap or beam.

### ***Bearing Layer Depth for Piles***

As previously discussed, we recommend that all piles penetrate at least 10 feet into Soil Unit 3, the bearing layer. Table 10 provides the depth to the bearing layer at specific exploration locations. The depth to the top of Soil Unit 3 varied from about 13 to 33 feet bgs in the soil borings but was typically encountered within about 25 feet bgs. The depth to the bearing layer could vary significantly within unexplored areas of the site.

Table 10 – Depth Top of Soil Unit 3 at Exploration Locations

Exploration ID	Depth to Bearing Layer (feet)
HC-3	27
HC-4	33
HC-5	Greater than 21.5
SW-B5	21
HC-6	13
HC-7	23
HC-B-5	26

The depth to the top of Soil Unit 3 is likely highly variable across the site; therefore, for estimating pile drilling and material quantities, we recommend adding 5 feet to the calculated pile lengths. The final pile lengths should be established during drilling based on interpreted soil conditions. If

unexpected subsurface conditions are encountered during construction, the pile lengths may need to be adjusted.

Note on that borings HC-5 and SW-B-5 were drilled close to each other; however, the SPT blowcounts in SW-B-5 are considerably higher at shallower depths than in HC-5, in fact HC-5 did not encounter suitable bearing soils to the depth drilled. This is indicative of a high potential for unexpected subsurface conditions and variability across the site that can cause uncertainty and variability of construction estimates and actual construction costs.

To reduce the uncertainty of as-built pile lengths and potential construction cost overruns, additional explorations could be done across the finalized building footprint to refine the depth to the top of Soil Unit 3. For the sake of time and cost efficiency, we recommend doing these explorations using a Cone Penetration Test (CPT) or drilled borings. These explorations should be done after the building location is finalized and the resulting information should be provided to pile contractors as part of the request for bid.

## GROUNDWATER CONTROL

### Temporary Construction Dewatering

Water collected and discharged during construction will include stormwater, groundwater, and process water from construction activities.

Groundwater was not encountered during drilling in most of the current and historical borings; however, borings HC-3, HC-4, and HC-7, encountered water at about 20 feet bgs. Also, historical reports (Hart Crowser 1979, Shannon & Wilson 1985) show accumulated groundwater in monitoring wells near the ground surface within several hours after drilling.

For the planned finish floor elevation of about elevation 88 to 91 feet, groundwater inflow is expected to be minimal during excavation, manageable using trenches and sumps. Excavations left open for several hours may accumulate groundwater near the ground surface. Deep excavations for building spaces below the finish floor, such as elevator pits, may require active dewatering prior to excavation. Active dewatering may include wellpoints or sumps installed around the perimeter of the excavation.

The amount of water discharged from the site depends on many factors including design and operation of the dewatering system (if applicable), the excavation depth and extent, and the variability in soil and groundwater properties. Note that rainfall, surface water, and groundwater from adjacent utility trenches can significantly increase short-term water discharge rates. Also, the time of year and nearby construction dewatering activities can affect groundwater flows.

## Permanent Drainage

### ***Walls Placed against Shoring***

We recommend installing drainage board (e.g., Miradrain 6100) between the shoring and permanent wall from the ground surface down to the full depth of the wall. The purpose of the drainage board is to prevent hydrostatic groundwater pressure buildup caused by surface water infiltration or perched groundwater above the water table. The drainage board can be connected to a pipe and discharged into a sump. We also recommend full coverage waterproofing for all below-grade, occupied spaces to provide a dry space. If the permanent wall has backfill behind it, install a perforated drain pipe at the bottom of the backfill to convey water to a suitable discharge point.

### ***Slabs-on-Grade***

- Slab-on-grade floors should be underlain by at least 6 inches of capillary break consisting of mineral aggregate Type 21 or Type 22, City of Seattle Standard Specification 9-03.16, with the exception that this material should have less than 10 percent sand and less than 3 percent fines.
- Any soil that is to be considered as capillary break and/or drainage material should be submitted to Hart Crowser for gradation analysis and approval.
- Provide underslab drainage using a combination of perimeter and cross drains. Drains should consist of perforated pipe placed in trenches at least 12 inches deep where the top of the trench is the bottom of the capillary break.
- Cross drains should be spaced about 30 to 40 feet apart and perimeter drains should extend around the perimeter of the building. The cross drains and the perimeter drains should be tied together and sloped to drain to a suitable discharge point.
- A layer of polyethylene sheeting should be used to protect the drainage layer from concrete as the floor slab is poured.
- Drainage material should be compacted to 90 percent of maximum dry density as determined by the Modified Proctor Method, ASTM D 1557.

### ***Backfilled Walls***

Walls with soil backfilled on one side only will require drainage or they must be designed for full hydrostatic pressure. We recommend the following:

- Backfill with a minimum thickness of 18 inches of free-draining sand or sand and gravel that is well-graded (i.e., has a wide range in particle size).
- Install drains behind any backfilled subgrade walls. The drains, with cleanouts, should consist of a minimum 4-inch-diameter perforated pipe that is placed on a bed of, and surrounded by, at least 6

inches of free-draining sand or sand and gravel. The drains should be sloped to carry the water to a sump or other suitable discharge.

- The backfill should be continuous and envelop the drainage behind the wall.
- The drainage fill surrounding the pipe should be compatible with the size of the holes in the pipe.
- Where dry interior spaces are required, backfilled walls should be waterproofed.

### ***Final Site Drainage***

The site should be graded in such a way that surface water will not pond near the structures. Roof drains should not be connected to the subgrade drainage system and should be sloped and tightlined to a suitable outlet away from the proposed building.

### ***Pavement Areas***

The pavement areas should be graded in such a way that surface water will not pond and will drain to a suitable outlet.

## **Pavement Design**

We understand that new pavement is limited to a fire lane that will approach the building from the south.

For asphalt pavement we recommend 6 inches of hot mix asphalt (HMA) in high-traffic or heavy-duty zones and 3 inches of HMA in light-duty zones. HMA should be underlain by 6 inches of crushed rock base course conforming to City of Seattle Standard Spec Aggregate Type 2 – 3/4" Minus Crushed Gravel.

The subgrade beneath the crushed rock base course should be compacted to 95 percent of maximum dry density as determined by the modified Proctor test (ASTM D 1557) or otherwise deemed acceptable by Hart Crowser. Where the existing subgrade consists of fine-grained native soils or uncontrolled fill, we recommend excavation and replacement with up to 1.5 feet of compacted structural fill. Structural fill should conform to City of Seattle Standard Spec Aggregate Type 17. The structural fill should be underlain by a woven geotextile such as Mirafi 500x or better.

## **GEOTECHNICAL RECOMMENDATIONS FOR CONSTRUCTION**

### **Recommendations for Soldier Pile Installation**

- Conditions such as caving soil and groundwater can loosen soil at the bottom of the soldier pile borehole and reduce bearing capacity in the zone of disturbed soil.

- Tieback de-tensioning and shoring failure could occur if bearing capacity is inadequate and soldier piles settle under the vertical component of the inclined tieback load. We recommend that a Hart Crowser representative closely monitor soldier pile installation for these conditions so that construction methods can be adjusted accordingly.
- The contractor should be prepared to case the soldier pile holes where loose soils or groundwater seepage could cause loss of ground. Fill soils can be especially prone to caving and may require casing. The actual need for casing should be determined in the field at the time of installation.
- If the shaft excavation contains water or slurry, the contractor should place backfill using a tremie. Lean mix, concrete, and controlled density fill should not be end-dumped through water or slurry.
- The contractor should be prepared to excavate the soldier piles in a manner that prevents heave or boiling at the bottom of the soldier pile excavation. It may be possible to over-drill the borehole and backfill the bottom of the borehole with structural concrete bearing on undisturbed soil.
- Drilling mud should not be used unless use of the mud is reviewed and approved by Hart Crowser, the shoring designer, and the structural engineer.
- Soldier-pile shoring construction may be difficult if cobbles or loose sand and gravel are encountered in the excavation. If these conditions are encountered, substantial soil raveling could occur.

## Recommendations for Lagging Installation

- Prompt and careful installation of lagging, particularly in areas of seepage and loose soil, is important to maintain the integrity of the excavation. The contractor should be prepared to place lagging in small vertical increments and to backfill voids caused by ground loss behind the shoring system. Proper installation to prevent soil failure and sloughing and loss of ground, and to provide safe working conditions, should be the responsibility of the shoring contractor.
- Backfill voids greater than 1 inch using sand, pea gravel, or a porous slurry. Backfill the void spaces progressively as the excavation deepens. The backfill must not allow hydrostatic pressure buildup behind the wall. Drainage behind the wall must be maintained or hydrostatic water pressure should be added to the recommended lateral earth pressures.
- If there is a slope above the wall, install extra lagging above the shoring wall to provide a partial barrier for material that could ravel down from the slope face and fall into the excavation.

## Recommendations for Tieback Installation

- Pump structural grout into the anchor zone using a grout hose or tremie hose placed at the bottom of the anchor.

- Fill the portion of the tieback in the no-load zone with a non-cohesive mixture of sand-pozzolan-water or equivalent; or, install a bond breaker such as plastic sheathing or a polyvinyl chloride (PVC) pipe around the tie rods within the no-load zone.
- Grout and backfill tiebacks immediately after placing the anchor. To prevent collapse of anchor holes, ground loss, and surface subsidence, do not leave anchor holes open overnight.
- Take care not to mine out large cavities in granular soil.
- If using pneumatic drilling techniques near utility vaults, corridors, or subgrade slabs, maintain continuous cutting return so those structures are not damaged by the air pressure.
- Install anchors to minimize ground loss and do not disturb previously installed anchors. During tieback drilling, wet or saturated zones may be encountered and caving or blow-in could occur. Drilling with a casing may reduce the potential for these conditions and ground loss.
- Test the tiebacks to confirm the appropriateness of the anchor design values and to verify that a suitable installation is achieved.

## Recommendations for Tieback Testing

The tieback anchor testing program should include verification testing of select tiebacks and proof testing of all production tiebacks. We recommend that tieback testing be done in general accordance with the recommendations in the publication Recommendations for Prestressed Rock and Soil Anchors by the Post Tensioning Institute (PTI 2004) and the recommendations below.

### **Verification Tests**

We recommend a minimum of two verification tests per soil type before installation of production anchors to validate the design pullout value. The geotechnical engineer will select the testing locations with input from the shoring subcontractor. The geotechnical engineer or shoring designer may require additional verification tests when creep susceptibility is suspected or when varying ground conditions are encountered.

Verification tiebacks should be installed by the same methods and personnel, using the same material and equipment, as the production tiebacks; the engineer will determine whether deviations require additional verification testing. At least two successful verification tests should be performed for each installation method and each soil type.

Verification tests load the tieback to 200 percent of the DL and include a 60-minute hold time at 150 percent of the DL. The tieback DLs will be on the shoring drawings. The tieback load should not exceed 80 percent of the steel's ultimate tensile strength. Verification test tiebacks should be incrementally loaded and unloaded using the schedule in Table 11.

Table 11 – Tieback Verification Test Schedule

Load Level	Hold Time
Alignment load	Until stable
0.25DL	10 min
0.5DL	10 min
0.75DL	10 min
1.0DL	10 min
1.25DL	10 min
<b>1.5DL</b>	<b>60 min</b>
1.75DL	10 min
2.0DL	10 min

The alignment load should be the minimum load required to align the testing assembly and should be less than 5 percent of the DL. The dial gauge should be zeroed after the alignment load has stabilized. Perform a creep test at 1.5DL by holding the load constant to within 50 psi and recording deflections at 1, 2, 3, 5, 6, 10, 20, 30, 50, and 60 minutes.

The acceptance criteria for a verification test are:

- The creep rate at 1.5DL is less than 0.08 inches between 6 and 60 minutes and the creep rate is linear or decreasing during the creep test;
- The total tieback displacement is greater than 80 percent of the theoretical elastic elongation of the design unbonded length plus the jack length; and
- The anchor does not pull out under repeated loading.

### ***Proof Tests***

Proof tests load the tieback to 1.33DL and include a 10-minute hold time at 1.33DL. The tieback DLs should be on the shoring drawings. The tieback load should not exceed 80 percent of the steel's ultimate tensile strength. Proof tests should be incrementally loaded and unloaded using the schedule in Table 12.

Table 12 – Tieback Proof Test Schedule

Load Level	Hold Time
Alignment load	Until stable
0.25DL	1 min
0.5DL	1 min
0.75DL	1 min
1.0DL	1 min
1.33DL	10 min



The alignment load should be the minimum load required to align the testing assembly and should be less than 5 percent of the design load. The dial gauge should be zeroed after the alignment load has stabilized.

The load should be held constant to within 50 psi and deflections recorded at 1, 2, 3, 5, 6 and 10 minutes. If the tieback deflection between 1 and 10 minutes at 1.33DL exceeds 0.04 inches, the load should be held for an additional 50 minutes and deflections recorded at 20, 30, 50, and 60 minutes.

The acceptance criteria for a proof test are:

- The creep rate at 1.33DL is less than 0.04 inches between 1 and 10 minutes or less than 0.08 inches between 6 and 60 minutes and the creep rate is linear or decreasing during the creep test;
- The total tieback displacement is greater than 80 percent of the theoretical elastic elongation of the design unbonded length plus the jack length; and
- The anchor does not pull out under repeated loading.

## Shoring Monitoring Program

A shoring monitoring program is recommended to provide early warning of shoring not performing as expected and to identify potential remedial measures. For this project, potential shoring includes a wall to retain soil cuts into the west slope and structures below finish grade, such as elevator or orchestra pits.

Prior to shoring, we recommend doing a pre-construction survey. A preconstruction survey documents the condition of pavement, utilities, buildings and upslope areas. The survey should include video and/or photographic documentation. The size and location of existing cracks in streets and buildings should receive special attention and may be monitored with a crack gauge.

During construction, we recommend optical surveys of horizontal and vertical movements of (1) the surface of the sloping ground above the building, (2) buildings adjacent to the site, and (3) the shoring system itself. The points on the adjacent buildings can be set either at the base or on the roof of the buildings. Points on the shoring should be set on every soldier pile.

For shoring that cuts into the west slope, we recommend installing a minimum of two slope inclinometer casings, one inclinometer casing attached to a soldier pile and the other inclinometer casing installed upslope from the shoring at a horizontal distance equal to the wall height.

The optical survey, or other measuring systems, should have an accuracy of at least 0.001 foot. All reference points on the ground surface should be installed and read before excavation begins. The frequency of readings will depend on the results of previous readings and the rate of construction. At a minimum, readings on the external points should be taken twice a week through construction until below-grade structural elements (such as floors, decks, columns) are completed, or as specified by the structural and geotechnical engineers. Readings on the top of soldier piles and the face of existing

buildings on or adjacent to the property should be taken at least twice a week during this time. We recommend that the owner hire an independent surveyor to record the data at least once per week; the surveyor or contractor could take the other weekly reading.

For buildings and streets adjacent to excavations we recommend a post-construction survey. A post-construction survey includes reviewing the preconstruction survey and comparing it to post-construction conditions. The survey should include video and/or photographic documentation. Changes in the number, size, or location of cracks in streets and buildings should be given special attention.

## Augercast Pile Construction

We recommend that we observe the installation of augercast piles, so we can evaluate the contractor's operation and collect and interpret the installation data. Because a completed pile is below the ground surface and cannot be observed during construction, judgment and experience must be used to aid in determining the acceptability of the pile. We recommend close monitoring of installation procedures such as installation sequence, auger withdrawal rate, grouting pressure, and quantity of grout used per pile. Variations from the established pattern, such as low grout pressure, excessive settlement of grout in a completed pile, etc., would make the pile susceptible to rejection.

We make the following recommendations for augercast pile installation:

- Do not install two piles within 5-pile diameters of each other (center to center spacing) within a 12-hour period. This is intended to prevent interconnection of grout between piles.
- Require the contractor to provide a pressure gage in the grout line.
- Minimum pressures should be those required to maintain a steady flow of grout to the auger. A typical value of 100 pounds per square inch (psi) should be used for this purpose.
- Rapid drops in the grout pressure of 50 psi or more occurring when otherwise accepted procedures are used should be specified as a possible cause for reconstructing the pile.
- The rate of grout injection and rate of auger withdrawal from the soils should be able to maintain a positive grout head of at least 10 feet above the bottom of the auger. Loss of head during grout injection due to interrupted grout flow should be remedied by reinsertion of the auger 5 to 10 feet below the depth at which the interruption occurred, or to the bottom of the pile if the depth is unknown.
- Withdraw auger from hole at a slow rate so that pressure on the grout column is maintained.
- Require contractor to provide a means of monitoring quantity of grout used per pile. A stroke counter on the grout pump is the most efficient means to obtain grout quantity. Each time a new grout pump is used a new calibration in cubic yards per stroke should be provided. Typically, the ratio of measured to theoretical grout volume should be maintained between 1.2 and 1.5.

- Require the contractor to rotate the auger after initial grout pumping (about 2 cubic feet) prior to the beginning of auger withdrawal to help establish a firm bearing condition at the end of the pile.

## Earthwork

### ***Site Preparation and Grading***

We recommend all site grading, paving, and any utility trenching be conducted during relatively dry weather conditions. At the time of our site explorations the ground surface was wet, soft and muddy. The existing ground surface is not suitable for construction traffic or staging areas. Working areas will need to be built using geotextile, quarry spalls, etc. Maintaining an adequate working surface should be the responsibility of the contractor.

It may be necessary to relocate or abandon some utilities. Excavation of these utility lines will probably occur through fill. Abandoned underground utilities should be removed or completely grouted. Ends of remaining abandoned utility lines should be sealed to prevent piping of soil or water into the pipe. Soft or loose backfill should be removed, and excavations should be backfilled with structural fill. Coordination with the utility agency is generally required.

### ***Structural Fill***

Backfill placed within the building area or below paved areas should be considered structural fill. We make the following recommendations for structural fill:

- For imported soil to be used as structural fill, use a clean, well-graded sand or sand and gravel with less than 5 percent by weight passing the No. 200 mesh sieve (based on the minus 3/4-inch fraction). Compaction of soil containing more than about 5 percent fines may be difficult if the material is wet or becomes wet during rainy weather.
- Place and compact all structural fill in lifts with a loose thickness no greater than 10 inches. For hand-operated “jumping jack” compactors, loose lifts should not exceed 6 inches. For small vibrating plate/sled compactors, loose lifts should not exceed 3 inches.
- Compact all structural fill to at least 95 percent of the modified Proctor maximum dry density (as determined by ASTM D 1557 test procedure).
- Control the moisture content of the fill to within 2 percent of the optimum moisture. Optimum moisture is the moisture content corresponding to the maximum Proctor dry density.
- In wet subgrade areas, clean material with a gravel content of at least 30 to 35 percent may be necessary. Gravel is material coarser than a US No. 4 sieve.
- Before filling begins, provide samples of the structural and drainage fill for laboratory testing. Laboratory testing will include a Proctor test and gradation for structural fill and a gradation for drainage fill. Field testing with a nuclear density gauge uses the maximum dry density determined

from a Proctor test so it is important to complete the laboratory testing as soon as possible in order to not delay backfilling.

### ***Use of On-Site Soil as Structural Fill***

Our explorations indicated that the near-surface site soil includes silty to very silty, slightly gravelly to gravelly sand, silt, and clay with scattered organic material; we do not recommend using these soils for structural fill.

### ***Temporary Cuts***

Because of the variables involved, actual slope grades required for stability in temporary cut areas can only be estimated before construction. We recommend that stability of the temporary slopes used for construction be the sole responsibility of the contractor, since the contractor is in control of the construction operation and is continuously at the site to observe the nature and condition of the subsurface. Excavations should be made in accordance with all local, state, and federal safety requirements.

The stability and safety of open trenches and cut slopes depend on a number of factors, including the soil conditions, seepage conditions, depth of cuts, duration, proximity to surcharge loads and soil stockpiles, and general care and methods used by the contractor.

Temporary excavations should either be shored or sloped in accordance with Part N, WAC 296-155-650 through 296-155-66411. For planning purposes, we recommend maximum temporary cuts of 2H:1V.

In addition to the WAC requirements, we recommend limiting the depth and duration of temporary cuts and using plastic sheeting to protect the soil from rain. Also, if groundwater seepage is encountered during excavation, the contractor should install temporary drainage to reduce caving or sloughing of cut faces and to protect adjacent soil from becoming wet and soft. Temporary cuts that encounter seepage may need to be flattened to maintain stability.

## **RECOMMENDATIONS FOR CONTINUING GEOTECHNICAL SERVICES**

Before construction begins, we recommend that we continue to meet with the design team, as needed, to address geotechnical questions that may arise throughout the remainder of the design and permitting process. We also recommend that we review the project plans and specifications to confirm that the geotechnical engineering recommendations have been properly interpreted.

During construction, we recommend that Hart Crowser be retained to perform the following tasks:

- Review contractor submittals;
- Observe shoring installation;

- Observe foundation installations;
- Observe foundation drainage installation;
- Other observations as required by the city of Mercer Island;
- Attend meetings, as needed; and
- Provide geotechnical engineering support that may arise during construction.

## REFERENCES

FHWA 1999. Geotechnical Engineering Circular No. 4, Ground Anchors and Anchored Systems. FHWA-IF-99-015. June 1999.

Hart Crowser 1980. Design Phase Subsurface Explorations and Geotechnical Engineering Study, Proposed Office Building And Parking Structure for Farmers New World Life Insurance Company, Mercer Island, Washington. January 4, 1980. J-857-01.

IBC 2012. International Building Code. International Code Council.

Post Tensioning Institute (PTI) 2004. Recommendations for Prestressed Rock and Soil Anchors, Third Edition.

Shannon & Wilson 1985. Preliminary Geotechnical Report, Mercer Island Civic Center, Mercer Island, Washington. August, 1985. Partial report accessed from the DNR Subsurface Geology Information System, Document ID 13758, <https://fortress.wa.gov/dnr/geology>.

Troost, K.G. & A.P. Wisher 2006. Geologic Map of Mercer Island, Washington. October, 2006.

Troost, K.G. & A.P. Wisher 2009. Mercer Island Landslide Hazard Assessment. April, 2009.

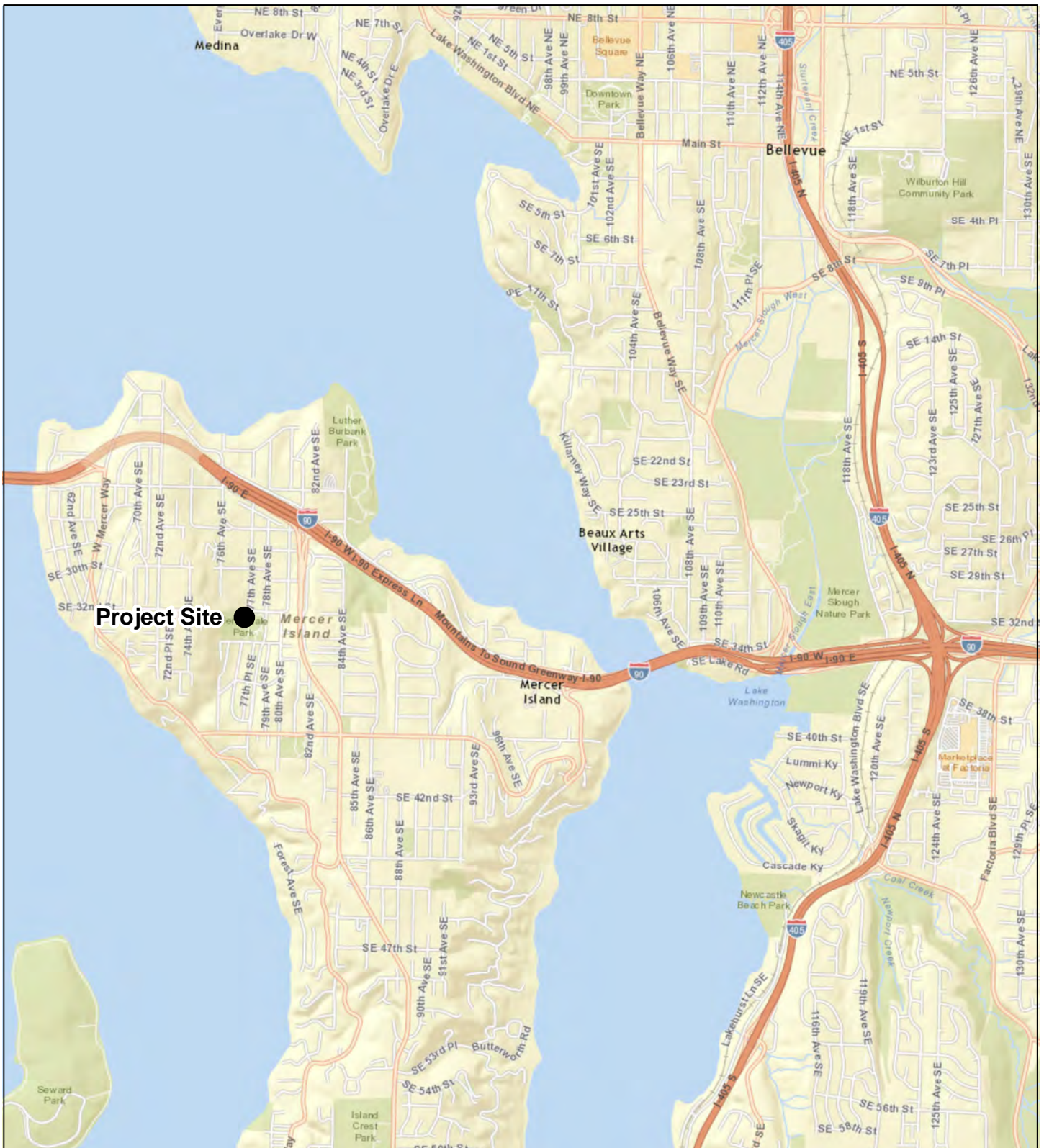

Sources: Esri, HERE, DeLorme, USGS, Intermap, increment P Corp., NRCAN, Esri Japan, METI, Esri China (Hong Kong), Esri (Thailand), TomTom, MapmyIndia, © OpenStreetMap contributors, and the GIS User Community

EAL 03/30/15 1912000-AB (V/Map).mxd

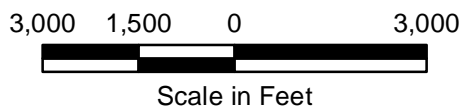

Mercer Island Center for the Arts Mercer Island, Washington	
<b>Vicinity Map</b>	
19120-00	3/15
	Figure <b>1</b>

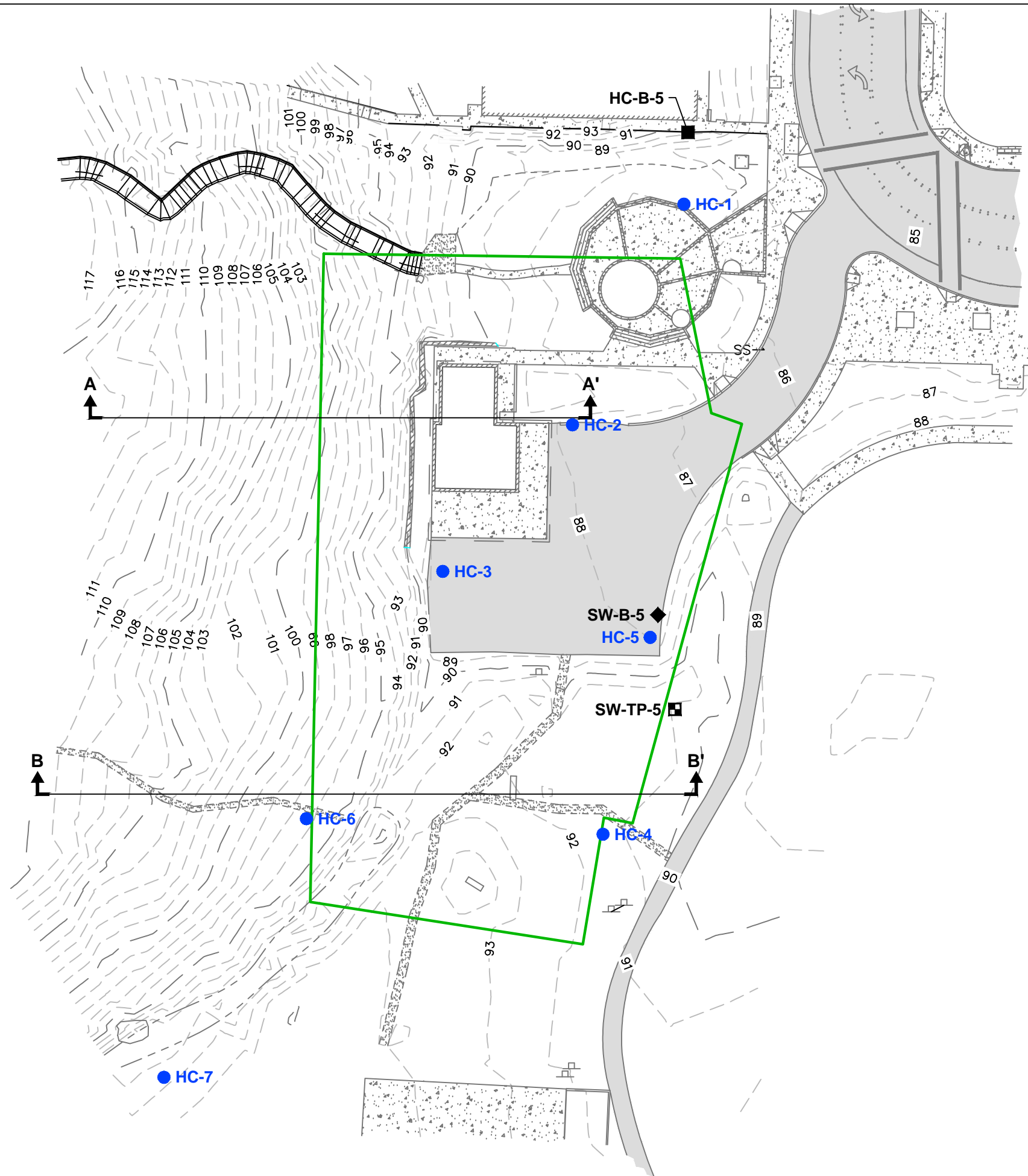

- Legend
- HC-1 ● Boring (Hart Crowser 2015)
  - SW-B-5 ◆ Boring (Shannon & Wilson 1985)
  - SW-TP-5 ■ Test Pit (Shannon & Wilson 1985)
  - HC-B-5 ■ Boring (Hart Crowser 1980)
  - Proposed building (Concept C)
  - A A' Cross section

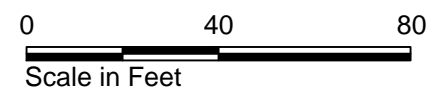

Mercer Island Center for the Arts Mercer Island, Washington	
<b>Site and Exploration Plan</b>	
19120-00	3/15
<b>HARTCROWSER</b>	Figure <b>2</b>

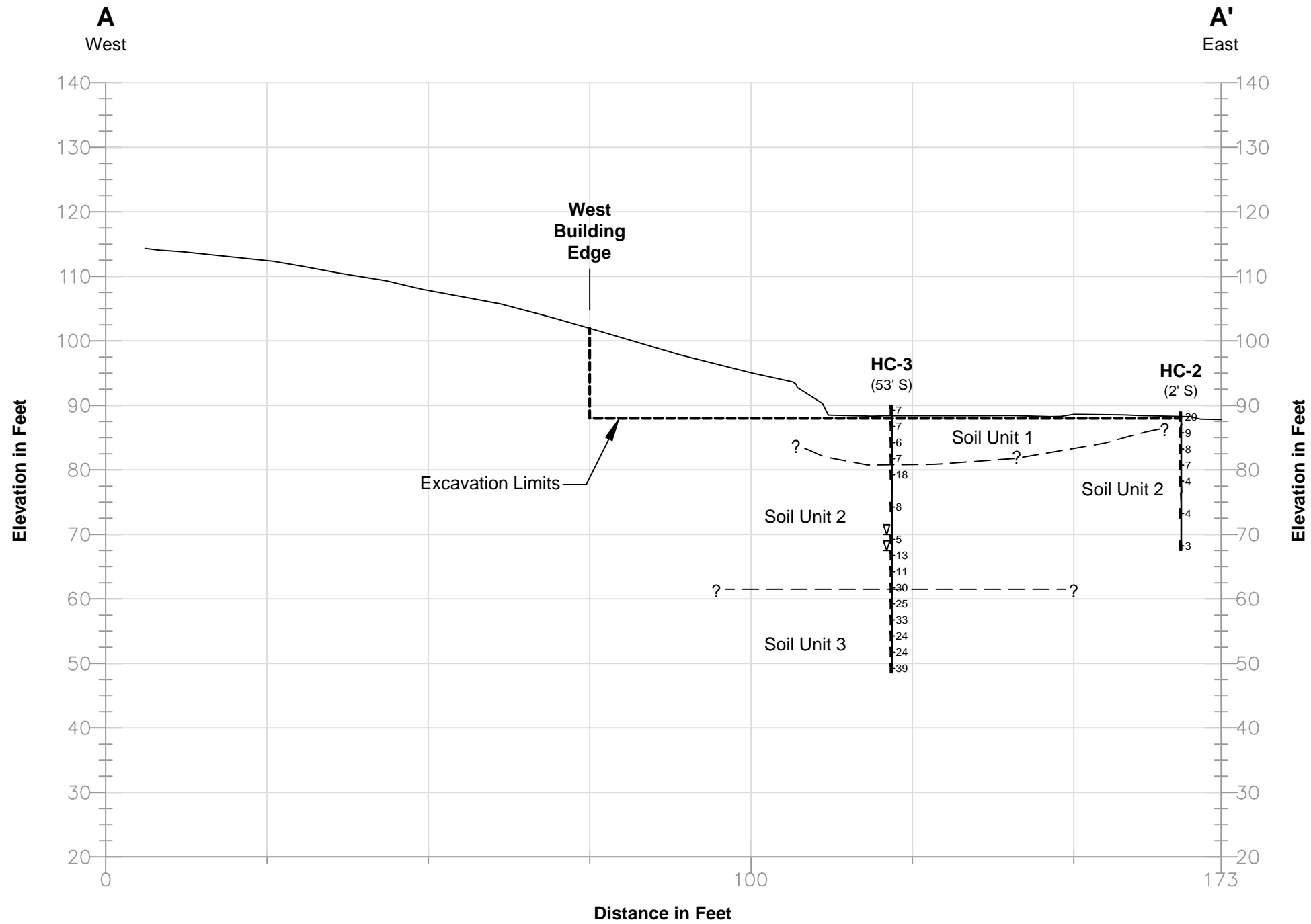

**HC-2** Exploration number  
(2' S) (Offset distance and direction)

Exploration

Water level

Standard penetration resistance in  
blows per foot

**Note:**  
Contact between soil units is interpolated between borings and represents our interpretation of subsurface conditions based on currently available data.



Mercer Island Center for the Arts Mercer Island, Washington	
<b>Generalized Subsurface Cross Section A-A'</b>	
19120-00	3/15
	Figure <b>3</b>



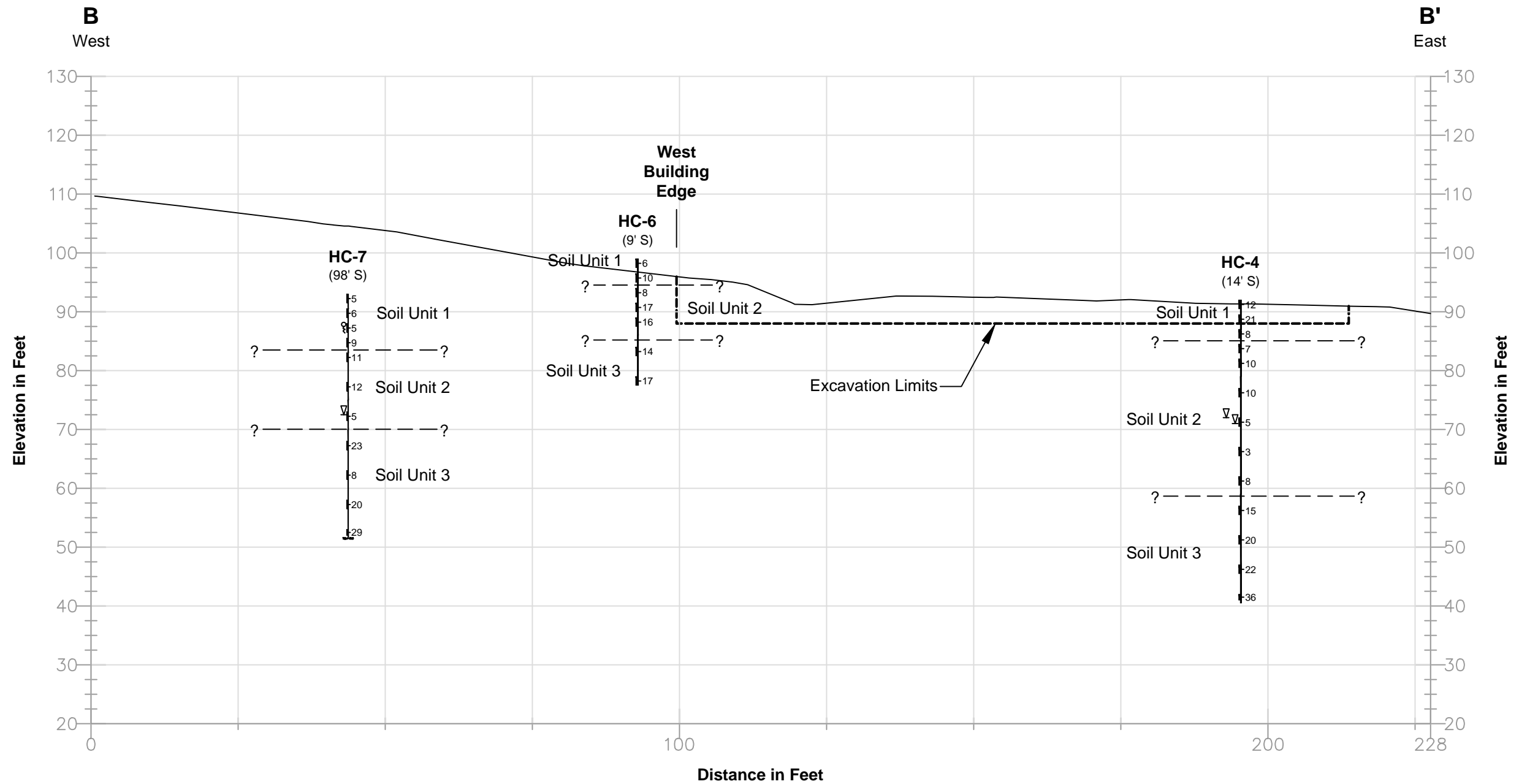

**Note:**  
Contact between soil units is interpolated between borings and represents our interpretation of subsurface conditions based on currently available data.

**HC-2** Exploration number  
(2' S) (Offset distance and direction)

- Exploration
- Water level
- Standard penetration resistance in blows per foot

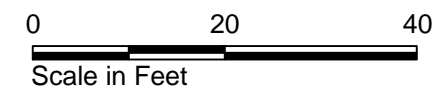

Mercer Island Center for the Arts Mercer Island, Washington	
<b>Generalized Subsurface Cross Section B-B'</b>	
19120-00	3/15
	Figure <b>4</b>

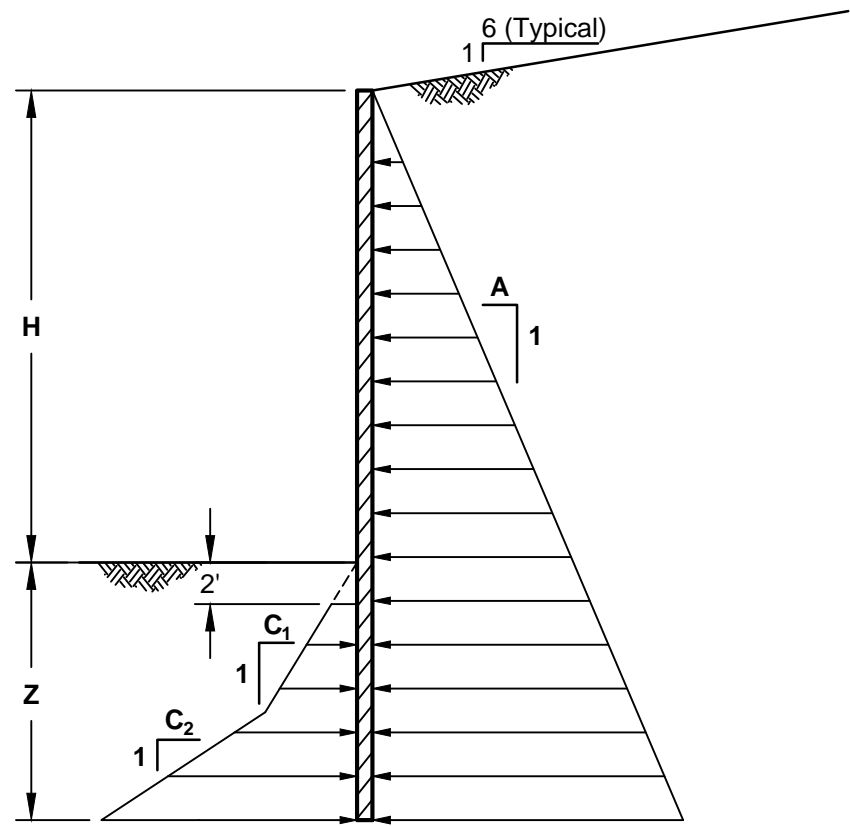

Passive Earth Pressure    Active Earth Pressure

**Cantilever Soldier Pile and Single-Braced Wall**

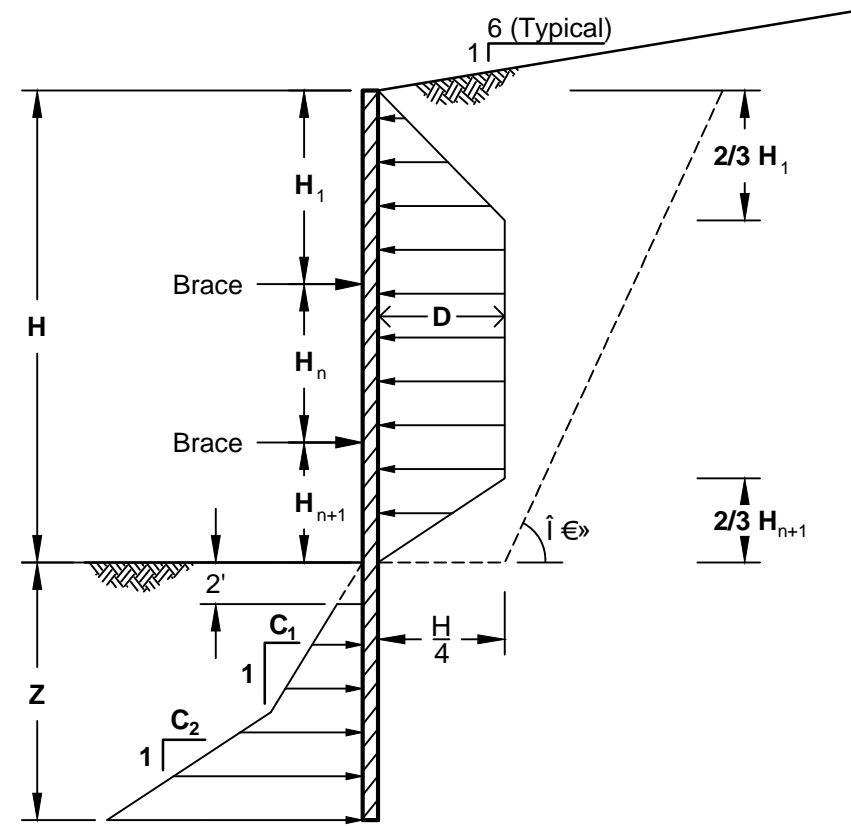

Passive Earth Pressure    Apparent Earth Pressure

**Multiple-Braced Wall**

**Recommended Lateral Earth Pressures**

	A	C <sub>1</sub> (Soil Units 1-2)	C <sub>2</sub> (Soil Unit 3)	D
Active	60 pcf	-	-	38H
Passive	-	215 pcf	350 pcf	-

**Notes:**

- For design, add 2 feet to the retained height.
- B and D are recommended equivalent uniform values.
- All earth pressures are in units of pounds per square foot.
- Minimum recommended embedment (Z) is 10 feet.
- Passive pressures are allowable values and include a 1.5 factor of safety.
- Passive pressure acts over 2.5 times the concreted diameter of the soldier pile or the pile spacing, whichever is less.
- Apparent earth pressure and surcharge act over the pile spacing above the base of the excavation.
- Active pressure acts over the pile diameter below the excavation.
- Additional surcharge (e.g. from footings, large stockpiles, heavy equipment), must be added to these pressures.
- All dimensions are in feet.
- Diagrams are not to scale.

**Legend**

- H            Total height of excavation (feet)
- H<sub>1</sub>         Depth to uppermost tieback (feet)
- H<sub>n</sub>         Height between tiebacks (feet)
- H<sub>n+1</sub>      Distance from base of excavation to lowermost tieback (feet)
- Z            Embedment depth (feet)
- A,B,C, ...   Earth pressure factors
- No-load zone

EAL 3/31/2015 L:\Notebooks\1912000\_ML Center for the Arts\CAD\1912000-001 (EPD)a

Mercer Island Center for the Arts Mercer Island, Washington	
<b>Lateral Earth Pressures for Temporary Shoring</b>	
19120-00	3/15
	Figure <b>5</b>

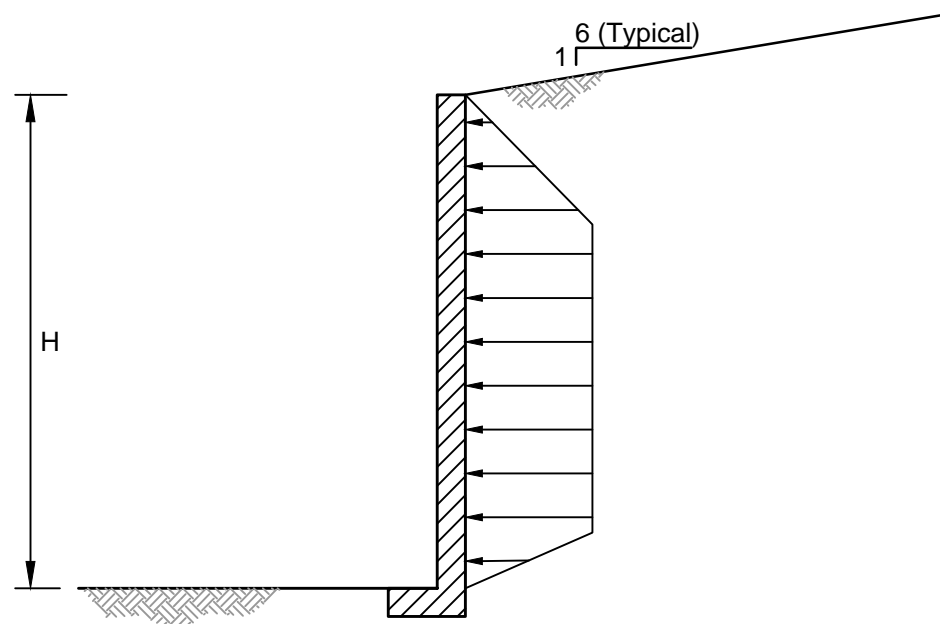

**Earth Pressure\***

\* The same earth pressure distributions determined for temporary shoring should be used for permanent walls constructed against shoring (See Figure 5).

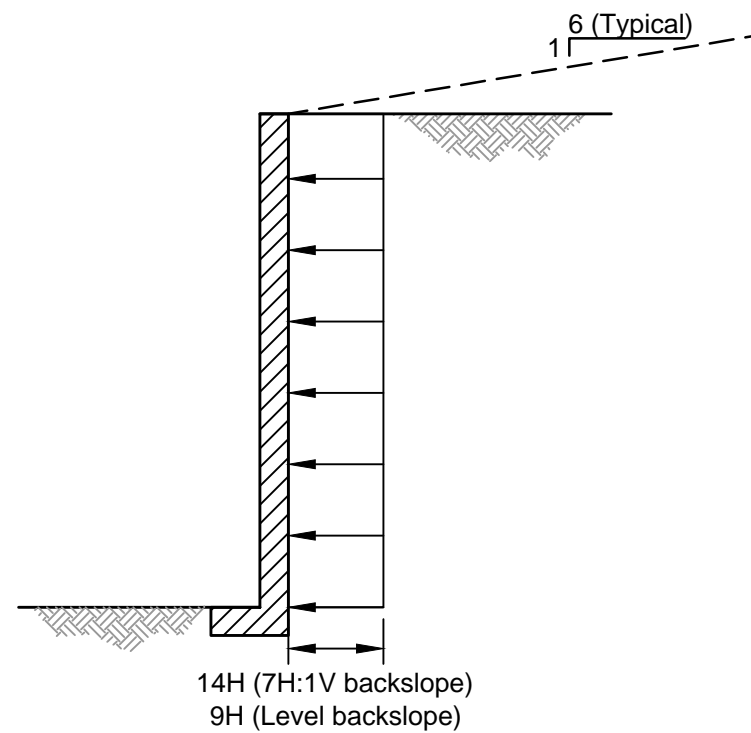

**Dynamic Inertial Increment**

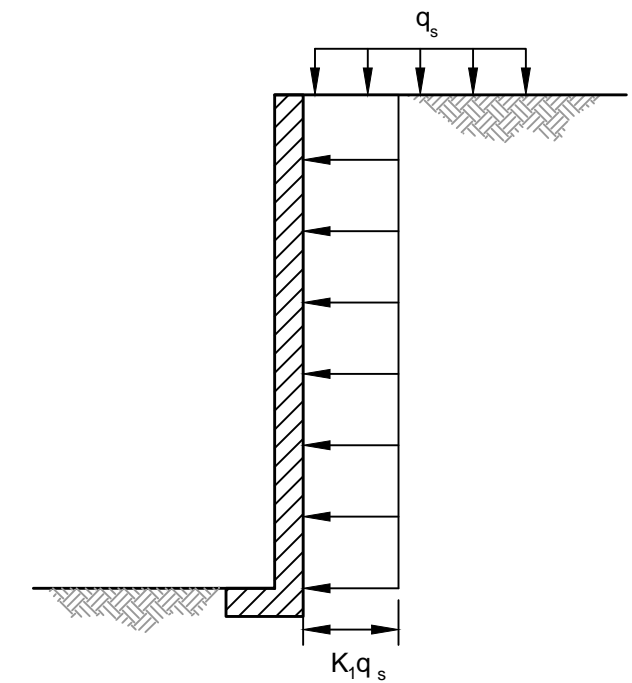

**Uniform Surcharge**

**Notes**

1. All pressures are in units of pounds per square foot.
2. Diagrams do not include surcharge loading due to adjacent structures; see Figure 7.
3. Diagrams not to scale.

**Legend**

- H Height from bottom of excavation to ground surface (feet)
- $q_s$  Traffic surcharge
- $h_w$  Depth of excavation below groundwater table

Mercer Island Center for the Arts Mercer Island, Washington	
<b>Lateral Pressures for Permanent Walls Constructed against Shoring</b>	
19120-00	3/15
 <b>HARTCROWSER</b>	Figure <b>6</b>

### A. Strip Footing Cross Section View

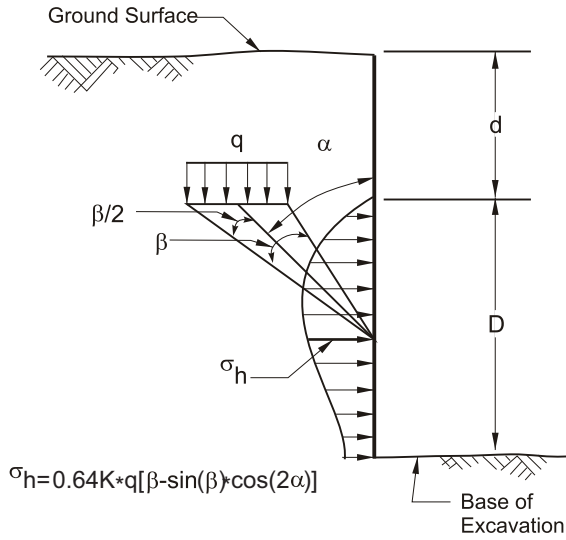

### B(1). Small Isolated Footing Cross Section View

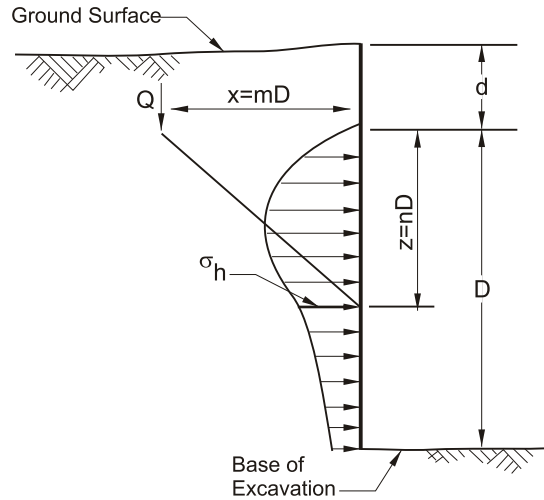

(For  $m > 0.4$ )

$$\sigma_h = K_1 \frac{1.77Q}{D^2} \frac{m^2 n^2}{(m^2 + n^2)^3}$$

(For  $m \leq 0.4$ )

$$\sigma_h = K_1 \frac{0.28Q}{D^2} \frac{n^2}{(0.16 + n^2)^3}$$

### C. Continuous Wall Footing Parallel to Excavation Cross Section View

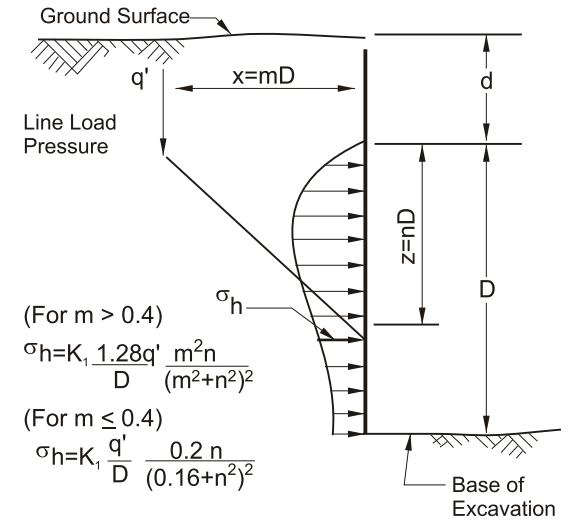

(For  $m > 0.4$ )

$$\sigma_h = K_1 \frac{1.28q' m^2 n}{D (m^2 + n^2)^2}$$

(For  $m \leq 0.4$ )

$$\sigma_h = K_1 \frac{q'}{D} \frac{0.2 n}{(0.16 + n^2)^2}$$

#### Definition and Units

- Q Footing Load in Pounds
- D Excavation Depth below Footing in Feet
- d Depth to Base of Footing in Feet
- $\sigma_h$  Lateral Soil Pressure in PSF
- q Unit Loading Pressure in PSF
- q' Footing Load in Pounds per Foot
- $\alpha, \beta$  Radians

### B(2). Plan View

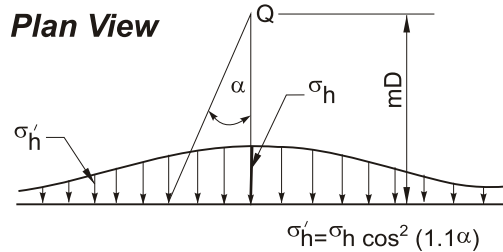

- Notes:
1. Lateral pressures from adjacent structures should be added to lateral pressures on Figures 5 and 6.
  2. Wall footings acting other than parallel to the excavation can be treated as series of discrete point loads, using Approach B.
  3. Contact Hart Crowser for surcharge recommendations, if necessary.

$K_1$	Conditions
0.35	Active earth pressure on a flexible wall (e.g., shoring)
0.5	At-rest conditions, where surcharge loads exist prior to excavation
1.0	At-rest conditions, where surcharge loads are applied after construction of permanent wall

Mercer Island Center for the Arts  
Mercer Island, Washington

**Determination of Lateral Pressure Acting on  
Adjacent Shoring from Surcharge Load**

19120-00

**HART CROWSER**

Figure 7  
3/15

# APPENDIX A

## Field Exploration Methods and Analysis

## APPENDIX A

### Field Exploration Methods and Analysis

This appendix documents the processes Hart Crowser used to determine the nature of the soils at the project site, and discusses:

- Explorations and their locations;
- Auger borings; and
- Standard Penetration Test procedures.

### Explorations and Their Locations

The exploration logs in this appendix show our interpretation of the drilling, sampling, and testing data. These logs indicate the approximate depth where the soils change. Note that the soil changes may be gradual and may vary in depth across the site.

In the field, we classified the soil samples according to the methods shown on Figure A-1 - Key to Exploration Logs. This figure also provides a legend explaining the symbols and abbreviations used on the logs.

Figure 2 shows the explorations, located with a measuring tape from existing physical features. Elevations are referenced to the North American Vertical Datum of 1988 (NAVD88) and were estimated from the provided topographic survey.

### Auger Borings

Borings were drilled with a 2.5-inch-inside-diameter, 6.5-inch-outside-diameter, hollow-stem auger and were advanced with a track-mounted drill rig subcontracted by Hart Crowser. The drilling was continuously observed by a geologist from Hart Crowser. A detailed field log was prepared for the boring. Using the Standard Penetration Test (SPT), we obtained samples at minimum 5-foot intervals.

### Standard Penetration Test Procedures

The SPT is an approximate measure of soil density and consistency. To be useful, the results must be interpreted in conjunction with other tests. The SPT (as described in ASTM D 1586) was used to obtain disturbed soil samples.

This test employs a standard 2-inch-outside-diameter, split-spoon sampler. Using a 140-pound autohammer, free-falling 30 inches, the sampler is driven into the soil for 18 inches. The number of blows required to drive the sampler the last 12 inches is the Standard Penetration Resistance. This resistance, or blow count, measures the relative density of granular soils and the consistency of cohesive soils. The blow counts are plotted on the boring logs at their respective sample depths.

Soil samples were recovered from the split-spoon sampler, field classified, and placed into watertight jars. They were taken to Hart Crowser's laboratory for further testing.

### ***In the Event of Hard Driving***

Occasionally, very dense materials preclude driving the total 18-inch sample. When this happens, the penetration resistance is entered on logs as follows:

**Penetration less than 6 inches.** The log indicates the total number of blows over the number of inches of penetration.

**Penetration greater than 6 inches.** The blow count noted on the log is the sum of the total number of blows completed after the first 6 inches of penetration. This sum is expressed over the number of inches driven that exceed the first 6 inches. The number of blows needed to drive the first 6 inches are not reported. For example, a blow count series of 12 blows for 6 inches, 30 blows for 6 inches, and 50 (the maximum number of blows counted within a 6-inch increment for SPT) for 3 inches would be recorded as 80/9.

# Key to Exploration Logs

## Sample Description

Classification of soils in this report is based on visual field and laboratory observations which include density/consistency, moisture condition, grain size, and plasticity estimates and should not be construed to imply field nor laboratory testing unless presented herein. Visual-manual classification methods of ASTM D 2488 were used as an identification guide.

Soil descriptions consist of the following:

Density/consistency, moisture, color, minor constituents, MAJOR CONSTITUENT, additional remarks.

### Density/Consistency

Soil density/consistency in borings is related primarily to the Standard Penetration Resistance. Soil density/consistency in test pits and probes is estimated based on visual observation and is presented parenthetically on the logs.

SAND or GRAVEL Density	Standard Penetration Resistance (N) in Blows/Foot	SILT or CLAY Consistency	Standard Penetration Resistance (N) in Blows/Foot	Approximate Shear Strength in TSF
Very loose	0 to 4	Very soft	0 to 2	<0.125
Loose	4 to 10	Soft	2 to 4	0.125 to 0.25
Medium dense	10 to 30	Medium stiff	4 to 8	0.25 to 0.5
Dense	30 to 50	Stiff	8 to 15	0.5 to 1.0
Very dense	>50	Very stiff	15 to 30	1.0 to 2.0
		Hard	>30	>2.0

### Sampling Test Symbols

	1.5" I.D. Split Spoon		Grab (Jar)		3.0" I.D. Split Spoon
	Shelby Tube (Pushed)		Bag		
	Cuttings		Core Run		

## SOIL CLASSIFICATION CHART

MAJOR DIVISIONS			SYMBOLS		TYPICAL DESCRIPTIONS	
			GRAPH	LETTER		
COARSE GRAINED SOILS  MORE THAN 50% OF MATERIAL IS LARGER THAN NO. 200 SIEVE SIZE	GRAVEL AND GRAVELLY SOILS	CLEAN GRAVELS  (LITTLE OR NO FINES)		<b>GW</b>	WELL-GRADED GRAVELS, GRAVEL - SAND MIXTURES, LITTLE OR NO FINES	
		GRAVELS WITH FINES  (APPRECIABLE AMOUNT OF FINES)		<b>GM</b>	POORLY-GRADED GRAVELS, GRAVEL - SAND MIXTURES, LITTLE OR NO FINES	
	SAND AND SANDY SOILS	CLEAN SANDS  (LITTLE OR NO FINES)		<b>SW</b>	WELL-GRADED SANDS, GRAVELLY SANDS, LITTLE OR NO FINES	
		SANDS WITH FINES  (APPRECIABLE AMOUNT OF FINES)		<b>SM</b>	POORLY-GRADED SANDS, GRAVELLY SAND, LITTLE OR NO FINES	
	FINE GRAINED SOILS  MORE THAN 50% OF MATERIAL IS SMALLER THAN NO. 200 SIEVE SIZE	SILTS AND CLAYS	LIQUID LIMIT LESS THAN 50		<b>ML</b>	INORGANIC SILTS AND VERY FINE SANDS, ROCK FLOUR, SILTY OR CLAYEY FINE SANDS OR CLAYEY SILTS WITH SLIGHT PLASTICITY
					<b>CL</b>	INORGANIC CLAYS OF LOW TO MEDIUM PLASTICITY, GRAVELLY CLAYS, SANDY CLAYS, SILTY CLAYS, LEAN CLAYS
LIQUID LIMIT GREATER THAN 50				<b>OL</b>	ORGANIC SILTS AND ORGANIC SILTY CLAYS OF LOW PLASTICITY	
		<b>MH</b>	INORGANIC SILTS, MICACEOUS OR DIATOMACEOUS FINE SAND OR SILTY SOILS			
		<b>CH</b>	INORGANIC CLAYS OF HIGH PLASTICITY			
				<b>OH</b>	ORGANIC CLAYS OF MEDIUM TO HIGH PLASTICITY, ORGANIC SILTS	
HIGHLY ORGANIC SOILS				<b>PT</b>	PEAT, HUMUS, SWAMP SOILS WITH HIGH ORGANIC CONTENTS	

NOTE: DUAL SYMBOLS ARE USED TO INDICATE BORDERLINE SOIL CLASSIFICATIONS

### Moisture

Dry	Little perceptible moisture
Damp	Some perceptible moisture, likely below optimum
Moist	Likely near optimum moisture content
Wet	Much perceptible moisture, likely above optimum

### Minor Constituents

### Estimated Percentage

Trace	<5
Slightly (clayey, silty, etc.)	5 - 12
Clayey, silty, sandy, gravelly	12 - 30
Very (clayey, silty, etc.)	30 - 50

### Laboratory Test Symbols

GS	Grain Size Classification
CN	Consolidation
UU	Unconsolidated Undrained Triaxial
CU	Consolidated Undrained Triaxial
CD	Consolidated Drained Triaxial
QU	Unconfined Compression
DS	Direct Shear
K	Permeability
PP	Pocket Penetrometer
	Approximate Compressive Strength in TSF
TV	Torvane
	Approximate Shear Strength in TSF
CBR	California Bearing Ratio
MD	Moisture Density Relationship
AL	Atterberg Limits
	Water Content in Percent
	Liquid Limit
	Natural Plastic Limit
PID	Photoionization Detector Reading
CA	Chemical Analysis
DT	In Situ Density in PCF
OT	Tests by Others

### Groundwater Indicators

	Groundwater Level on Date or (ATD) At Time of Drilling
	Groundwater Seepage (Test Pits)

### Sample Key

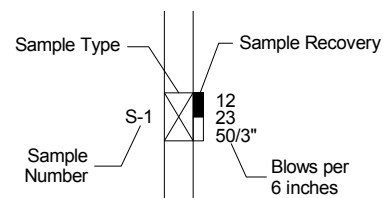

**HARTCROWSER**

19120-00

2/15

Figure A-1



# Boring Log HC-1

Approx. Location: 47.581844, -122.235290  
 Approximate Ground Surface Elevation: 87  
 Horizontal Datum: WGS84  
 Vertical Datum: NAVD88

Drill Equipment: Bobcat Minitrack (MT55)  
 Hammer Type: SPT  
 Hole Diameter: 6.5 inches  
 Logged By: M. Smith Reviewed By: M. Veenstra

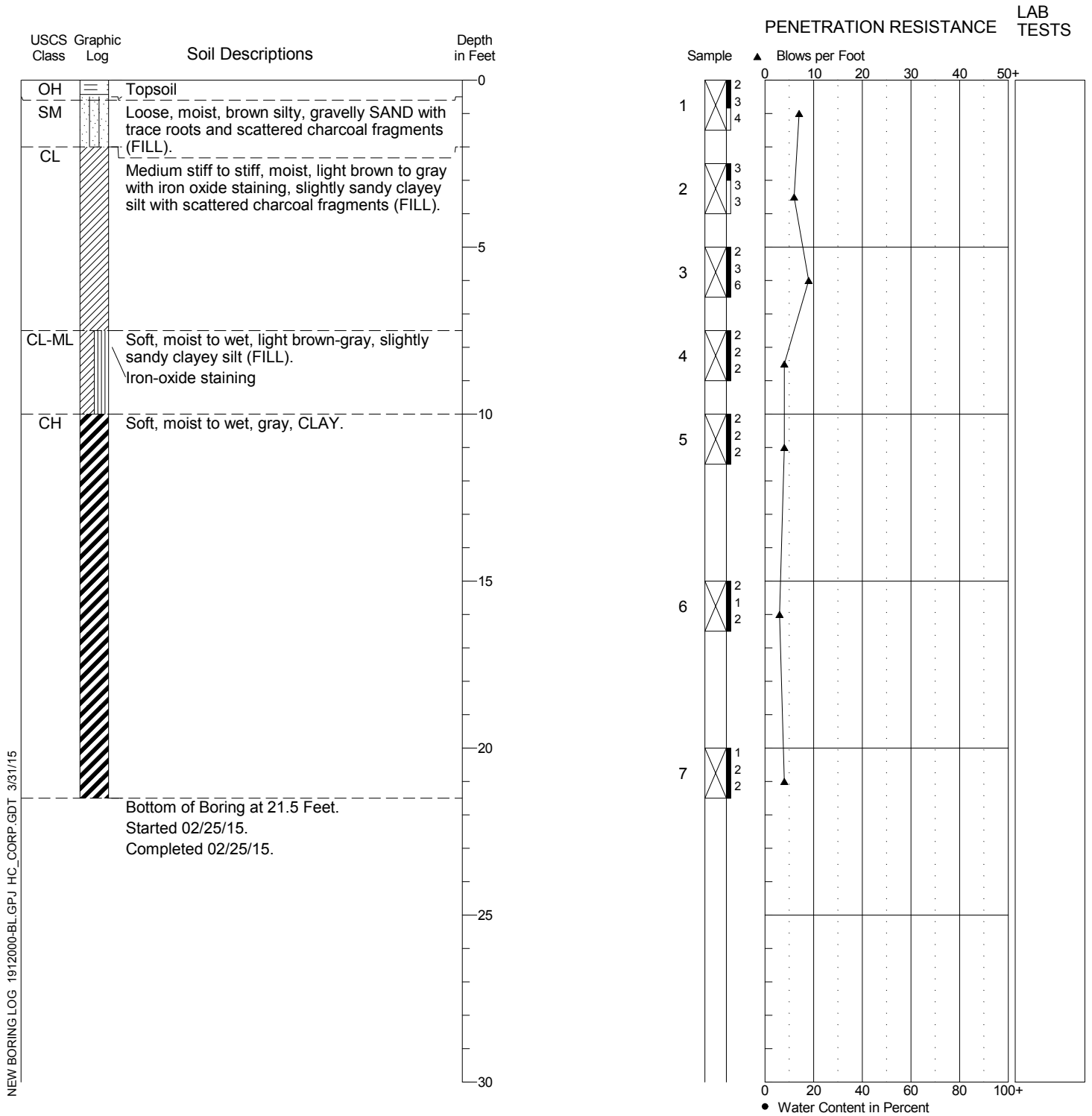

1. Refer to Figure A-1 for explanation of descriptions and symbols.
2. Soil descriptions and stratum lines are interpretive and actual changes may be gradual.
3. USCS designations are based on visual manual classification (ASTM D 2488) unless otherwise supported by laboratory testing (ASTM D 2487).
4. Groundwater level, if indicated, is at time of drilling (ATD) or for date specified. Level may vary with time.

# Boring Log HC-2

Approx. Location: 47.581633, -122.235440  
 Approximate Ground Surface Elevation: 89  
 Horizontal Datum: WGS84  
 Vertical Datum: NAVD88

Drill Equipment: Bobcat Minitrack (MT55)  
 Hammer Type: SPT  
 Hole Diameter: 6.5 inches  
 Logged By: M. Smith Reviewed By: M. Veenstra

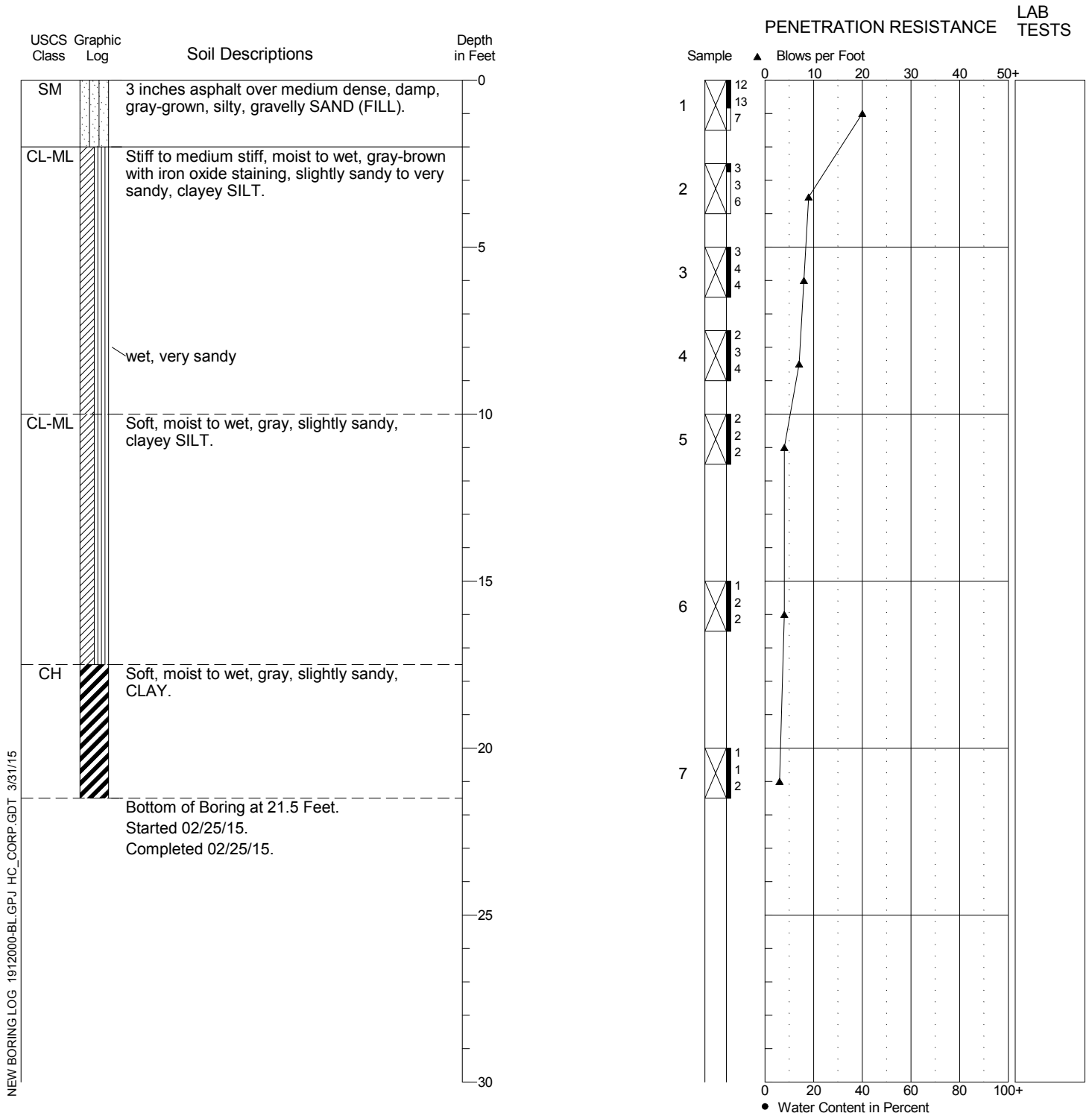

1. Refer to Figure A-1 for explanation of descriptions and symbols.
2. Soil descriptions and stratum lines are interpretive and actual changes may be gradual.
3. USCS designations are based on visual manual classification (ASTM D 2488) unless otherwise supported by laboratory testing (ASTM D 2487).
4. Groundwater level, if indicated, is at time of drilling (ATD) or for date specified. Level may vary with time.

# Boring Log HC-3

Approx. Location: 47.581493, -122.235618  
 Approximate Ground Surface Elevation: 90  
 Horizontal Datum: WGS84  
 Vertical Datum: NAVD88

Drill Equipment: Bobcat Minitrack (MT55)  
 Hammer Type: SPT  
 Hole Diameter: 6.5 inches  
 Logged By: M. Smith Reviewed By: M. Veenstra

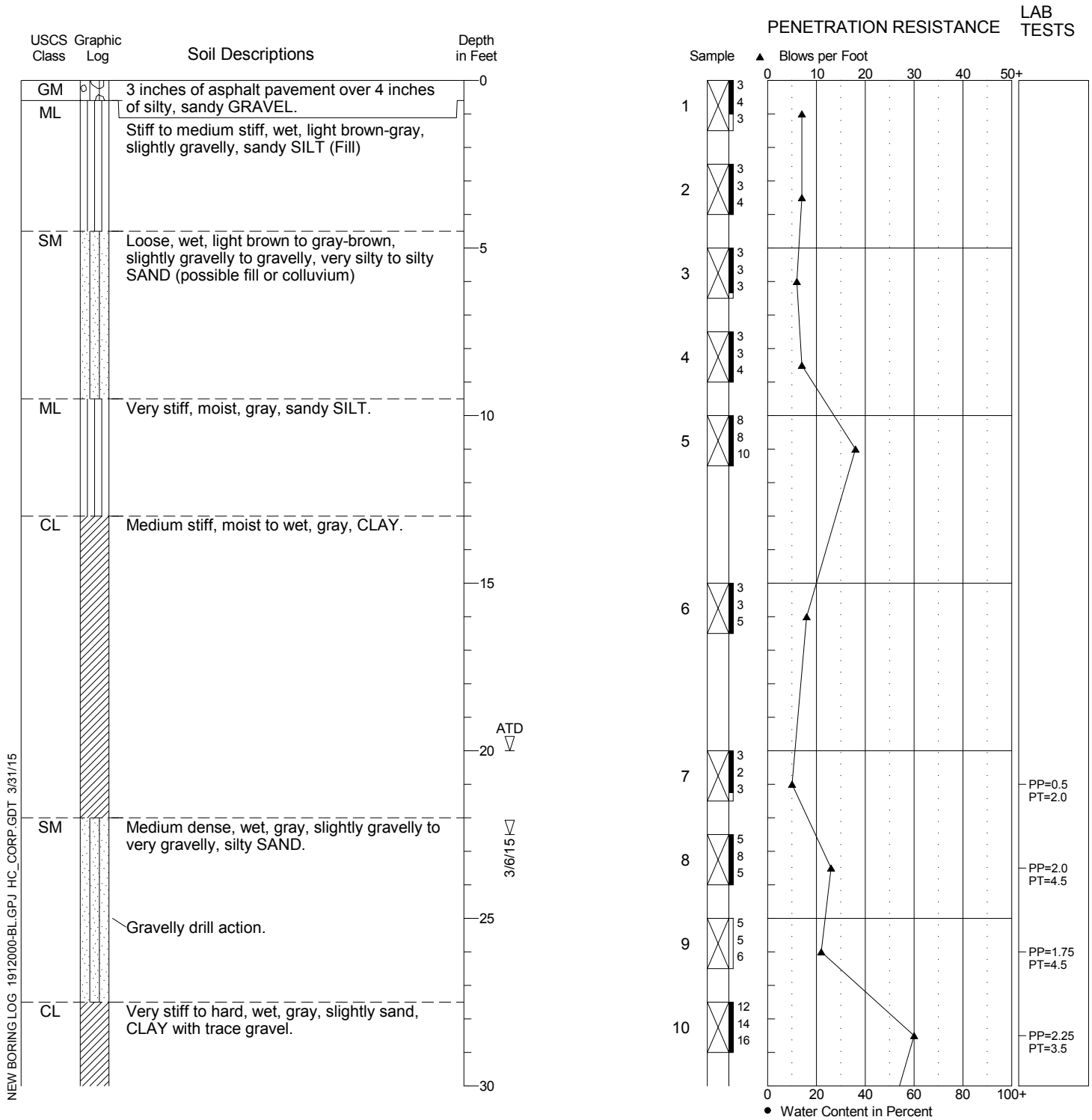

1. Refer to Figure A-1 for explanation of descriptions and symbols.
2. Soil descriptions and stratum lines are interpretive and actual changes may be gradual.
3. USCS designations are based on visual manual classification (ASTM D 2488) unless otherwise supported by laboratory testing (ASTM D 2487).
4. Groundwater level, if indicated, is at time of drilling (ATD) or for date specified. Level may vary with time.

# Boring Log HC-3

Approx. Location: 47.581493, -122.235618  
 Approximate Ground Surface Elevation: 90  
 Horizontal Datum: WGS84  
 Vertical Datum: NAVD88

Drill Equipment: Bobcat Minitrack (MT55)  
 Hammer Type: SPT  
 Hole Diameter: 6.5 inches  
 Logged By: M. Smith Reviewed By: M. Veenstra

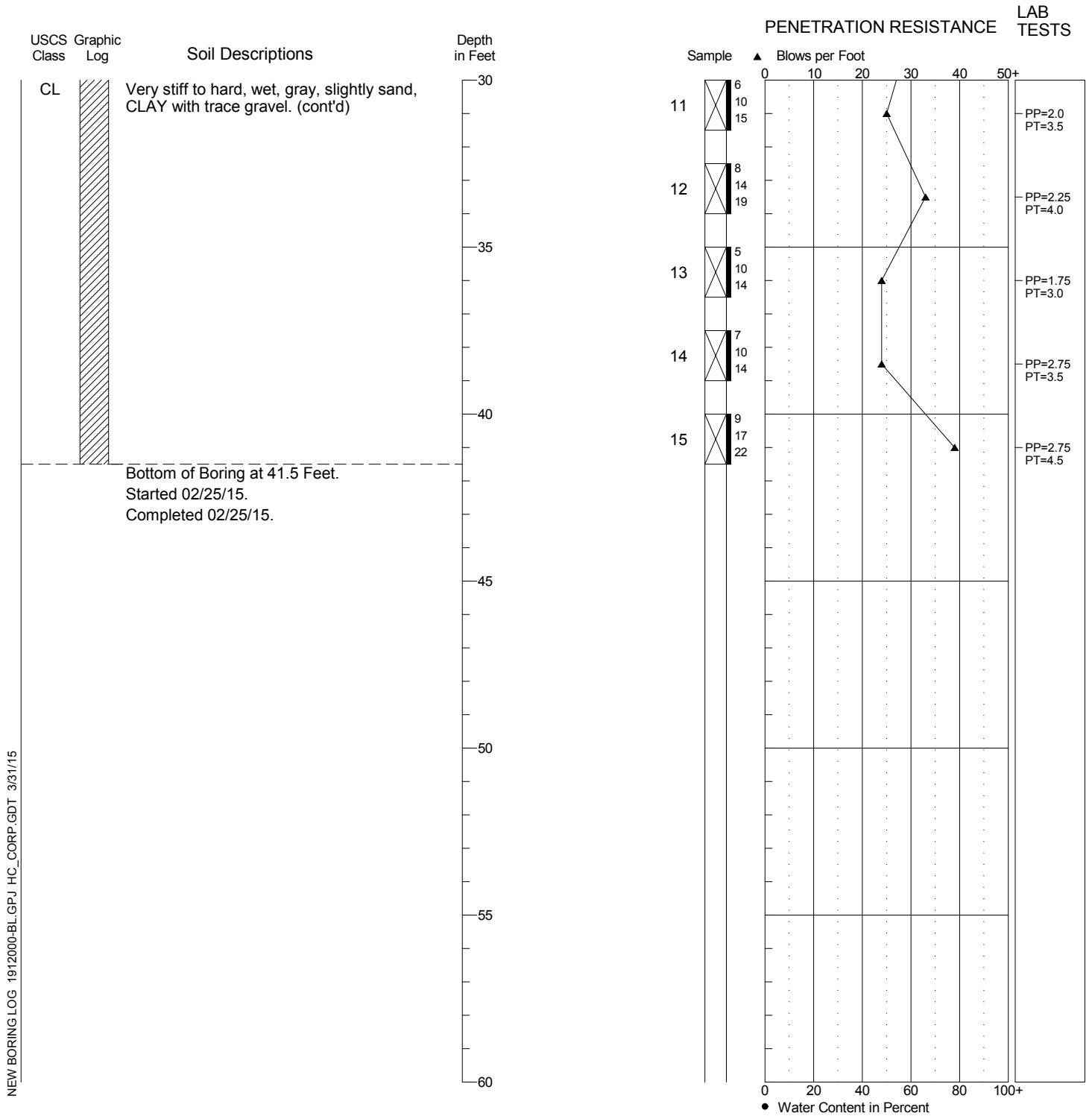

NEW BORING LOG 1912000-BL.GPJ HC\_CORP.GDT 3/31/15

1. Refer to Figure A-1 for explanation of descriptions and symbols.
2. Soil descriptions and stratum lines are interpretive and actual changes may be gradual.
3. USCS designations are based on visual manual classification (ASTM D 2488) unless otherwise supported by laboratory testing (ASTM D 2487).
4. Groundwater level, if indicated, is at time of drilling (ATD) or for date specified. Level may vary with time.

# Boring Log HC-4

Approx. Location: 47.581246, -122.235387  
 Approximate Ground Surface Elevation: 92  
 Horizontal Datum: WGS84  
 Vertical Datum: NAVD88

Drill Equipment: Bobcat Minitrack (MT55)  
 Hammer Type: SPT  
 Hole Diameter: 6.5 inches  
 Logged By: M. Smith Reviewed By: M. Veenstra

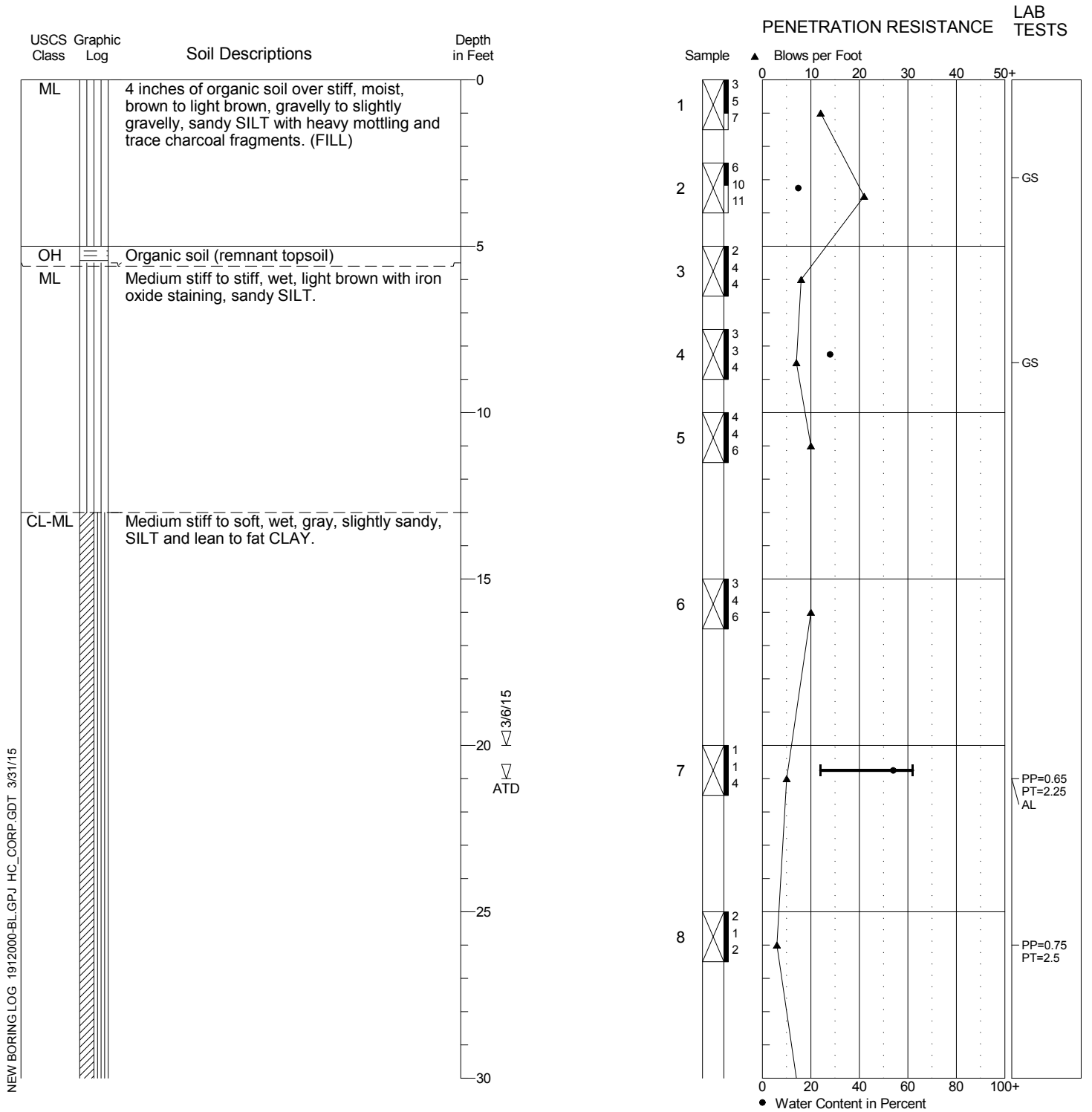

1. Refer to Figure A-1 for explanation of descriptions and symbols.
2. Soil descriptions and stratum lines are interpretive and actual changes may be gradual.
3. USCS designations are based on visual manual classification (ASTM D 2488) unless otherwise supported by laboratory testing (ASTM D 2487).
4. Groundwater level, if indicated, is at time of drilling (ATD) or for date specified. Level may vary with time.



19120-00

2/15

Figure A-5

1/2

# Boring Log HC-4

Approx. Location: 47.581246, -122.235387  
 Approximate Ground Surface Elevation: 92  
 Horizontal Datum: WGS84  
 Vertical Datum: NAVD88

Drill Equipment: Bobcat Minitrack (MT55)  
 Hammer Type: SPT  
 Hole Diameter: 6.5 inches  
 Logged By: M. Smith Reviewed By: M. Veenstra

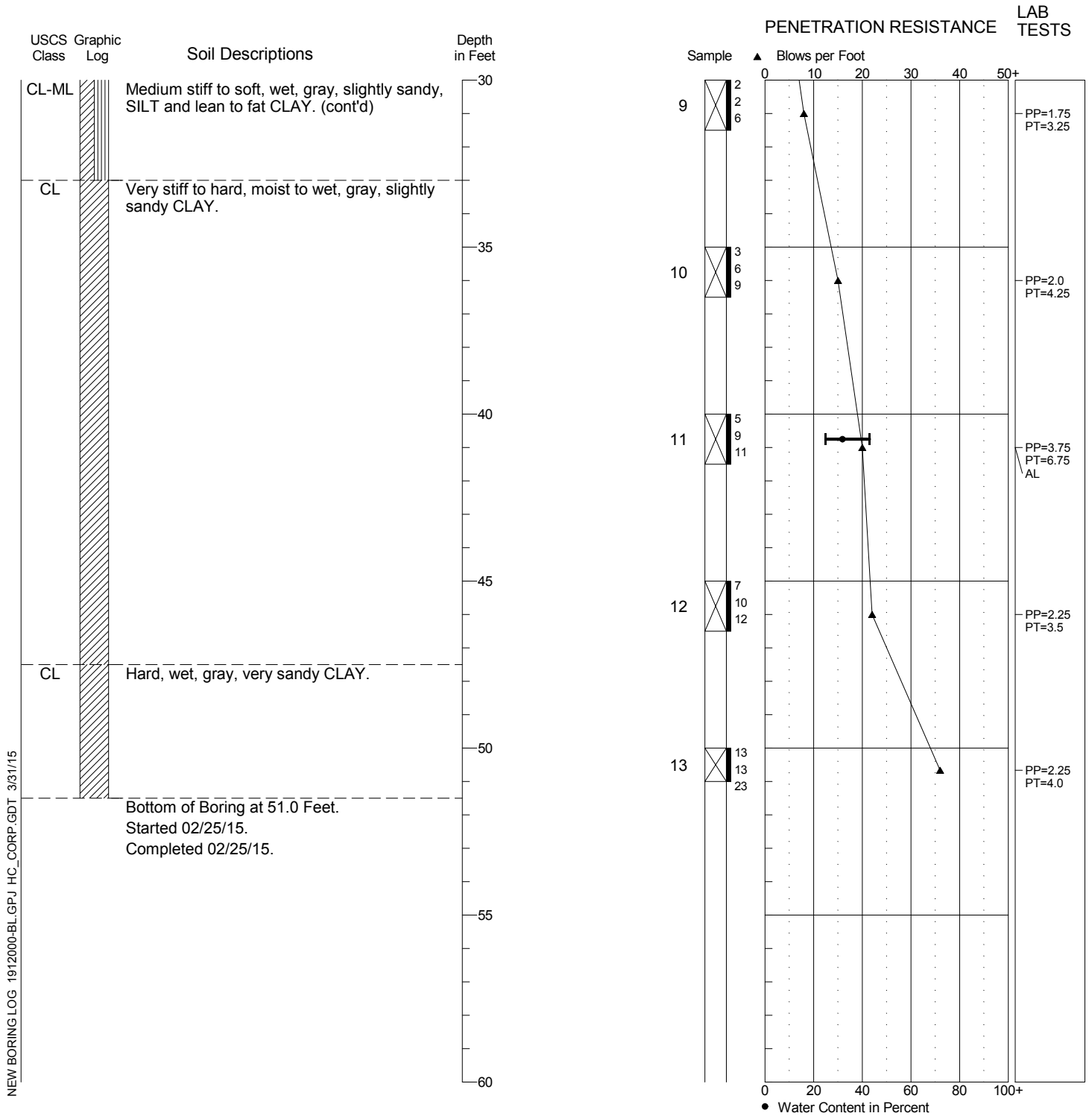

1. Refer to Figure A-1 for explanation of descriptions and symbols.
2. Soil descriptions and stratum lines are interpretive and actual changes may be gradual.
3. USCS designations are based on visual manual classification (ASTM D 2488) unless otherwise supported by laboratory testing (ASTM D 2487).
4. Groundwater level, if indicated, is at time of drilling (ATD) or for date specified. Level may vary with time.

# Boring Log HC-5

Approx. Location: 47.581433, -122.235326  
 Approximate Ground Surface Elevation: 88  
 Horizontal Datum: WGS84  
 Vertical Datum: NAVD88

Drill Equipment: Bobcat Minitrack (MT55)  
 Hammer Type: SPT  
 Hole Diameter: 6.5 inches  
 Logged By: M. Smith Reviewed By: M. Veenstra

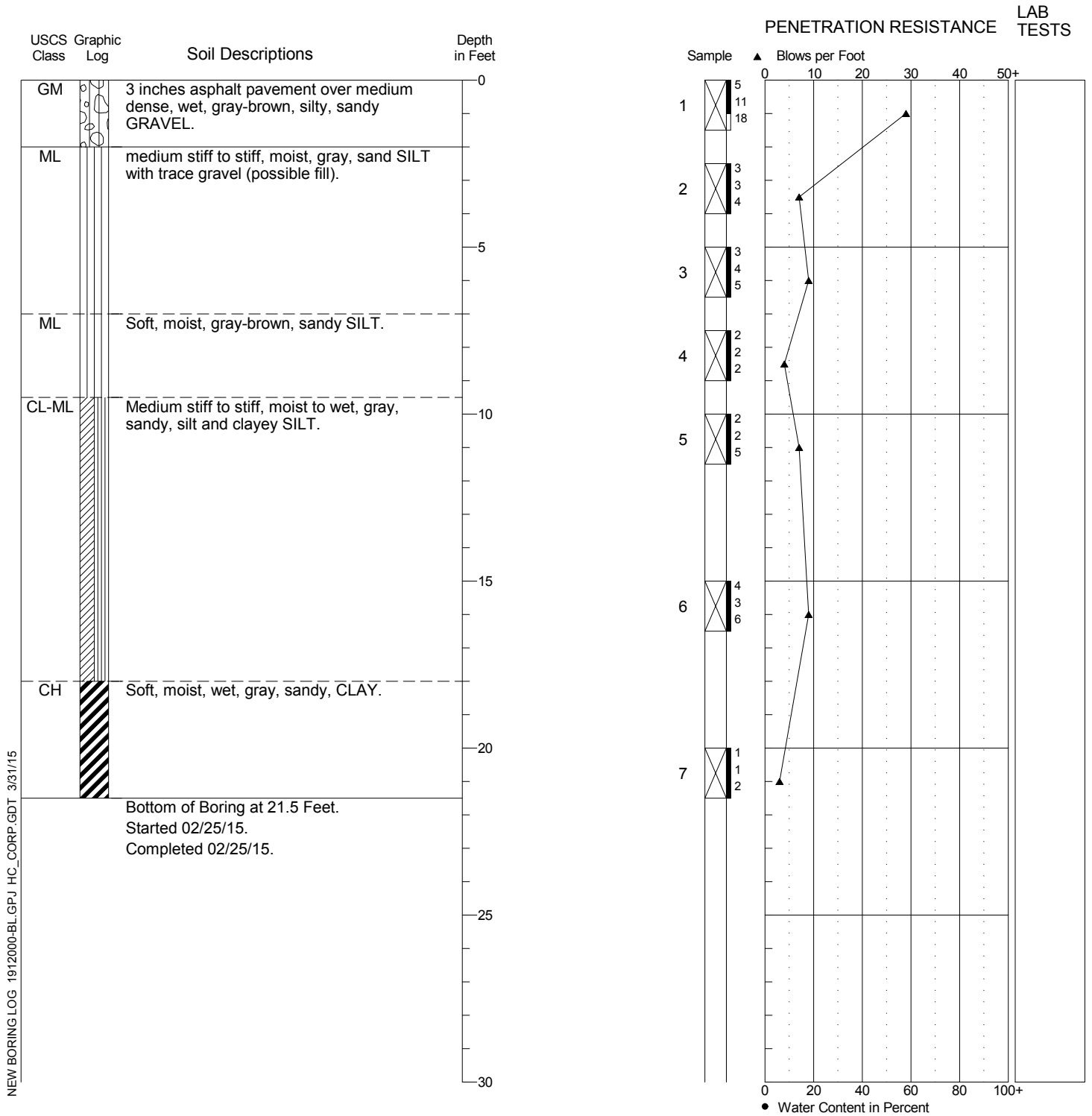

1. Refer to Figure A-1 for explanation of descriptions and symbols.
2. Soil descriptions and stratum lines are interpretive and actual changes may be gradual.
3. USCS designations are based on visual manual classification (ASTM D 2488) unless otherwise supported by laboratory testing (ASTM D 2487).
4. Groundwater level, if indicated, is at time of drilling (ATD) or for date specified. Level may vary with time.

# Boring Log HC-6

Approx. Location: 47.581256, -122.235803  
 Approximate Ground Surface Elevation: 99  
 Horizontal Datum: WGS84  
 Vertical Datum: NAVD88

Drill Equipment: Bobcat Minitrack (MT55)  
 Hammer Type: SPT  
 Hole Diameter: 6.5 inches  
 Logged By: M. Smith Reviewed By: M. Veenstra

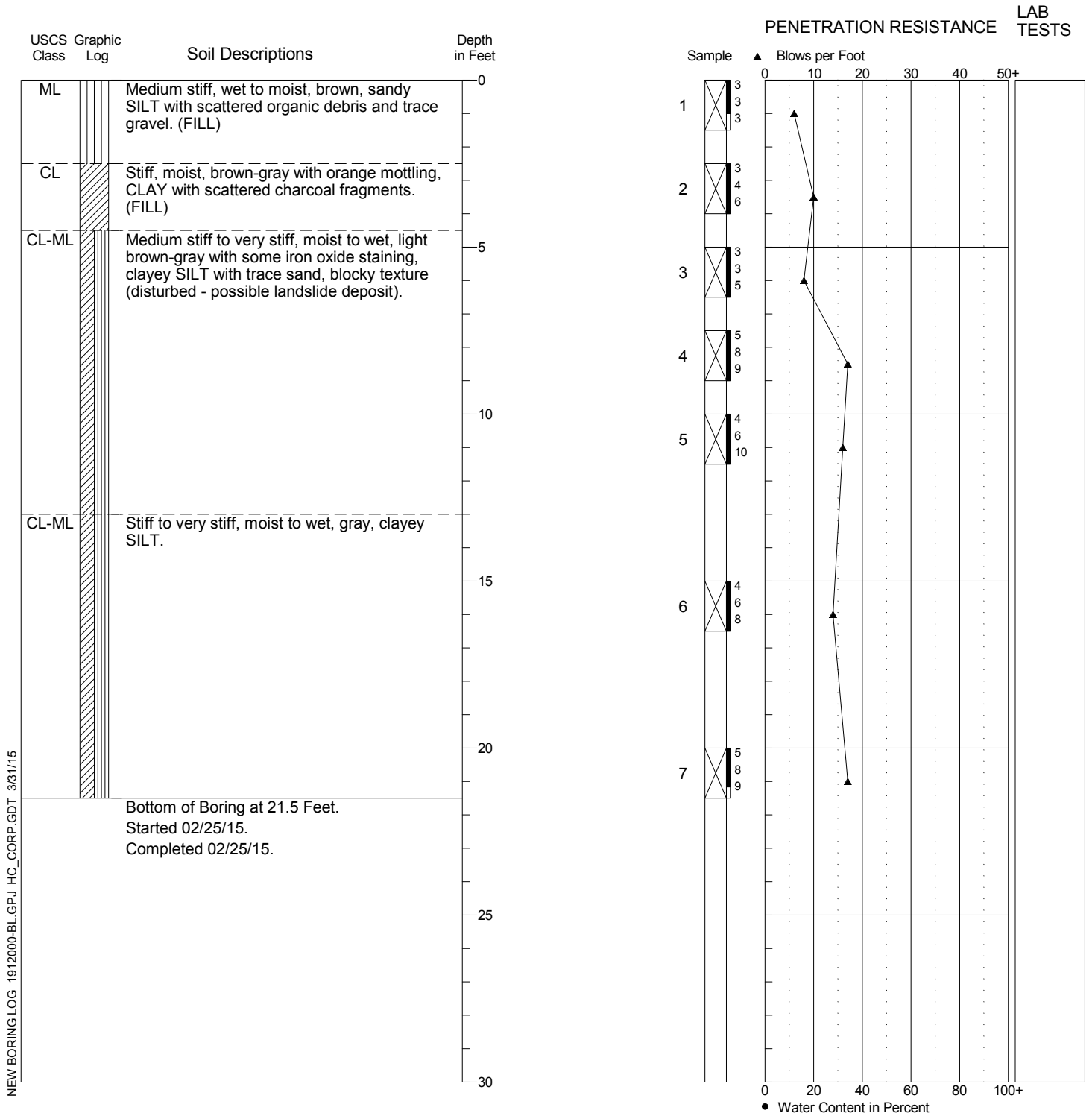

NEW BORING LOG 1912000-BL.GPJ HC\_CORP.GDT 3/31/15

1. Refer to Figure A-1 for explanation of descriptions and symbols.
2. Soil descriptions and stratum lines are interpretive and actual changes may be gradual.
3. USCS designations are based on visual manual classification (ASTM D 2488) unless otherwise supported by laboratory testing (ASTM D 2487).
4. Groundwater level, if indicated, is at time of drilling (ATD) or for date specified. Level may vary with time.



# Boring Log HC-7

Approx. Location: 47.581010, -122.235996  
 Approximate Ground Surface Elevation: 93  
 Horizontal Datum: WGS84  
 Vertical Datum: NAVD88

Drill Equipment: Bobcat Minitrack (MT55)  
 Hammer Type: SPT  
 Hole Diameter: 6.5 inches  
 Logged By: M. Smith Reviewed By: M. Veenstra

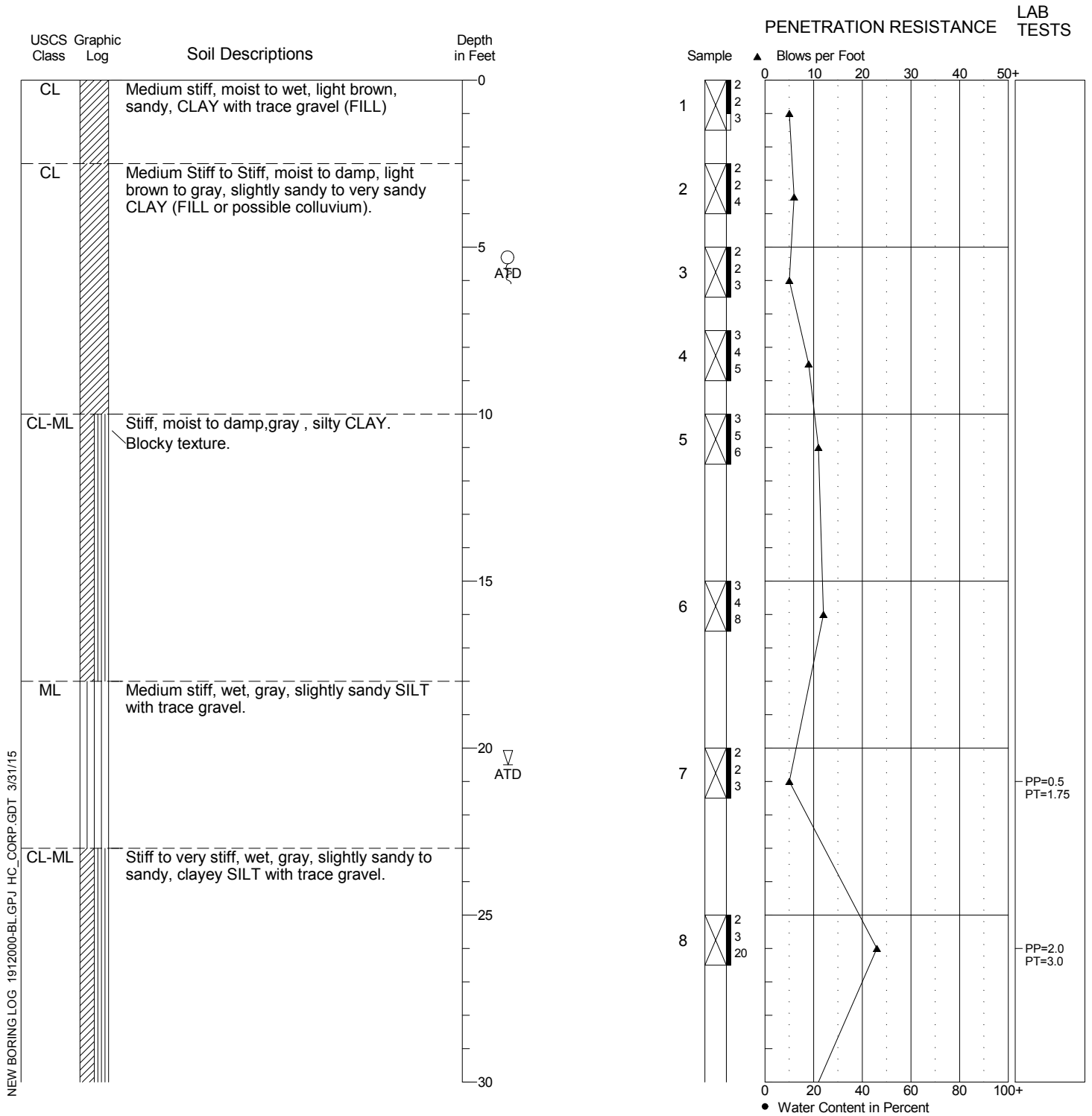

1. Refer to Figure A-1 for explanation of descriptions and symbols.
2. Soil descriptions and stratum lines are interpretive and actual changes may be gradual.
3. USCS designations are based on visual manual classification (ASTM D 2488) unless otherwise supported by laboratory testing (ASTM D 2487).
4. Groundwater level, if indicated, is at time of drilling (ATD) or for date specified. Level may vary with time.

# Boring Log HC-7

Approx. Location: 47.581010, -122.235996  
 Approximate Ground Surface Elevation: 93  
 Horizontal Datum: WGS84  
 Vertical Datum: NAVD88

Drill Equipment: Bobcat Minitrack (MT55)  
 Hammer Type: SPT  
 Hole Diameter: 6.5 inches  
 Logged By: M. Smith Reviewed By: M. Veenstra

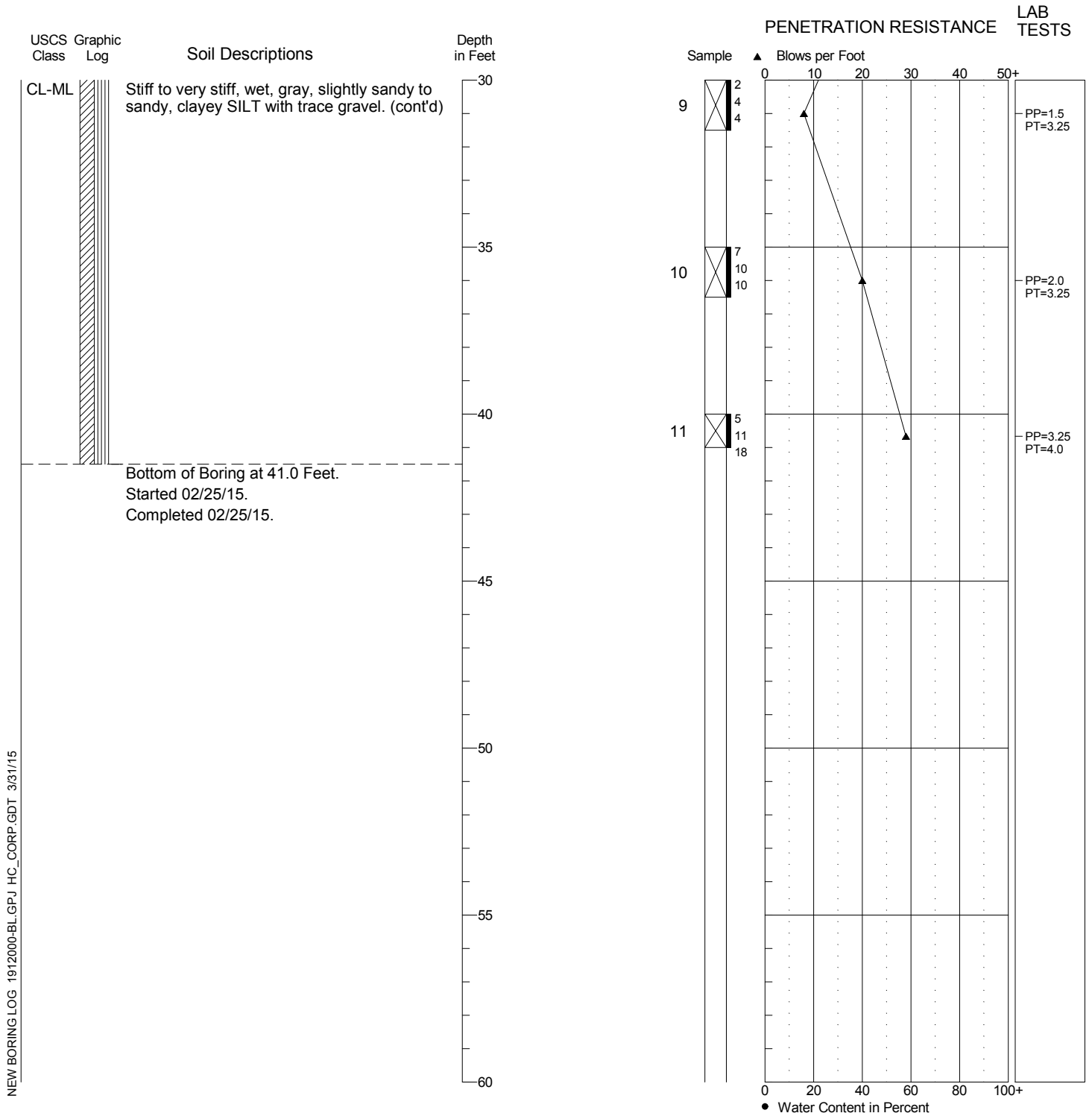

NEW BORING LOG 1912000-BL.GPJ HC\_CORP.GDT 3/31/15

1. Refer to Figure A-1 for explanation of descriptions and symbols.
2. Soil descriptions and stratum lines are interpretive and actual changes may be gradual.
3. USCS designations are based on visual manual classification (ASTM D 2488) unless otherwise supported by laboratory testing (ASTM D 2487).
4. Groundwater level, if indicated, is at time of drilling (ATD) or for date specified. Level may vary with time.

# APPENDIX B

## Laboratory Testing Program

## APPENDIX B

### Laboratory Testing Program

A laboratory testing program was performed for this study to evaluate the basic index and geotechnical engineering properties of the site soils. Both disturbed and relatively undisturbed samples were tested. The tests performed and the procedures followed are outlined below.

#### ***Soil Classification***

Soil samples from the explorations were visually classified in the field and then taken to our laboratory where the classifications were verified in a relatively controlled laboratory environment. Field and laboratory observations include density/consistency, moisture condition, and grain size and plasticity estimates.

The classifications of selected samples were checked by laboratory tests such as Atterberg limits determinations and grain size analysis. Classifications were made in general accordance with the Unified Soil Classification (USC) System, ASTM D 2487, as presented on Figure B-1.

#### ***Atterberg Limits***

We determined Atterberg limits for selected fine-grained soil samples. The liquid limit and plastic limit were determined in general accordance with ASTM D4318-84. The results of the Atterberg limits analyses and the plasticity characteristics are summarized in the Liquid and Plastic Limits Test Report, Figures B-2 and B-3. This relates the plasticity index (liquid limit minus the plastic limit) to the liquid limit. The results of the Atterberg limits tests are shown graphically on the boring logs as well as where applicable on figures presenting various other test results.

#### ***Grain Size Analysis***

Grain size distribution was analyzed on representative samples in general accordance with ASTM D 422. Wet sieve analysis was used to determine the size distribution greater than the US No. 200 mesh sieve. The size distribution for particles smaller than the No. 200 mesh sieve was determined by the hydrometer method for a selected number of samples. The results of the tests are presented as curves plotting percent finer by weight versus grain size.

#### ***Water Content Determination***

Water content was determined for several samples in general accordance with ASTM D 2216, as soon as possible following their arrival in our laboratory. Water content was not determined for very small samples or samples where large gravel content would result in unrepresentative values. The results of these tests are plotted at the respective sample depth on the exploration logs.

# Unified Soil Classification (USC) System

## Soil Grain Size

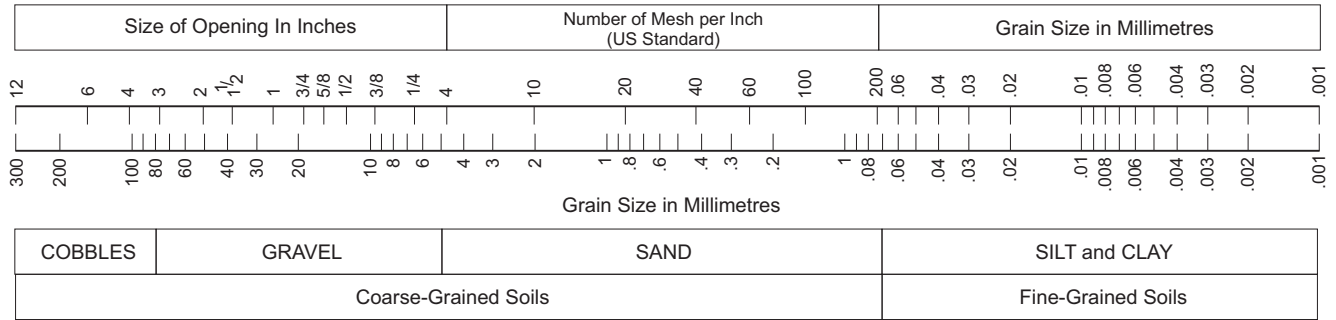

### Coarse-Grained Soils

<b>G W</b>	<b>G P</b>	<b>G M</b>	<b>G C</b>	<b>S W</b>	<b>S P</b>	<b>S M</b>	<b>S C</b>
Clean GRAVEL <5% fines		GRAVEL with >12% fines		Clean SAND <5% fines		SAND with >12% fines	
GRAVEL >50% coarse fraction larger than No. 4				SAND >50% coarse fraction smaller than No. 4			
Coarse-Grained Soils >50% larger than No. 200 sieve							

$$G W \text{ and } S W \left( \frac{D_{60}}{D_{10}} \right) > 4 \text{ for } G W \quad \& \quad 1 \leq \left( \frac{D_{30}^2}{D_{10} \times D_{60}} \right) \leq 3$$

G P and S P Clean GRAVEL or SAND not meeting requirements for G W and S W

G M and S M Atterberg limits below A line with PI <4

G C and S C Atterberg limits above A Line with PI >7

\* Coarse-grained soils with percentage of fines between 5 and 12 are considered borderline cases requiring use of dual symbols.

D<sub>10</sub>, D<sub>30</sub>, and D<sub>60</sub> are the particles diameter of which 10, 30, and 60 percent, respectively, of the soil weight are finer.

### Fine-Grained Soils

<b>ML</b>	<b>CL</b>	<b>OL</b>	<b>MH</b>	<b>CH</b>	<b>OH</b>	<b>Pt</b>
SILT	CLAY	Organic	SILT	CLAY	Organic	Highly Organic Soils
Soils with Liquid Limit <50%			Soils with Liquid Limit >50%			
Fine-Grained Soils >50% smaller than No. 200 sieve						

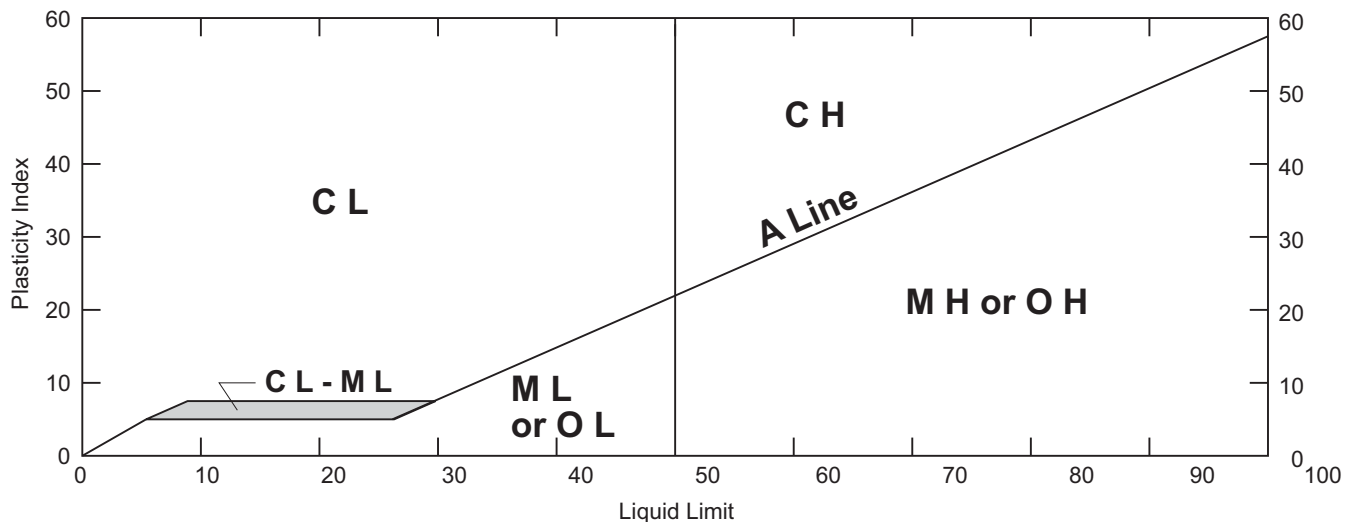

## Liquid and Plastic Limits Test Report

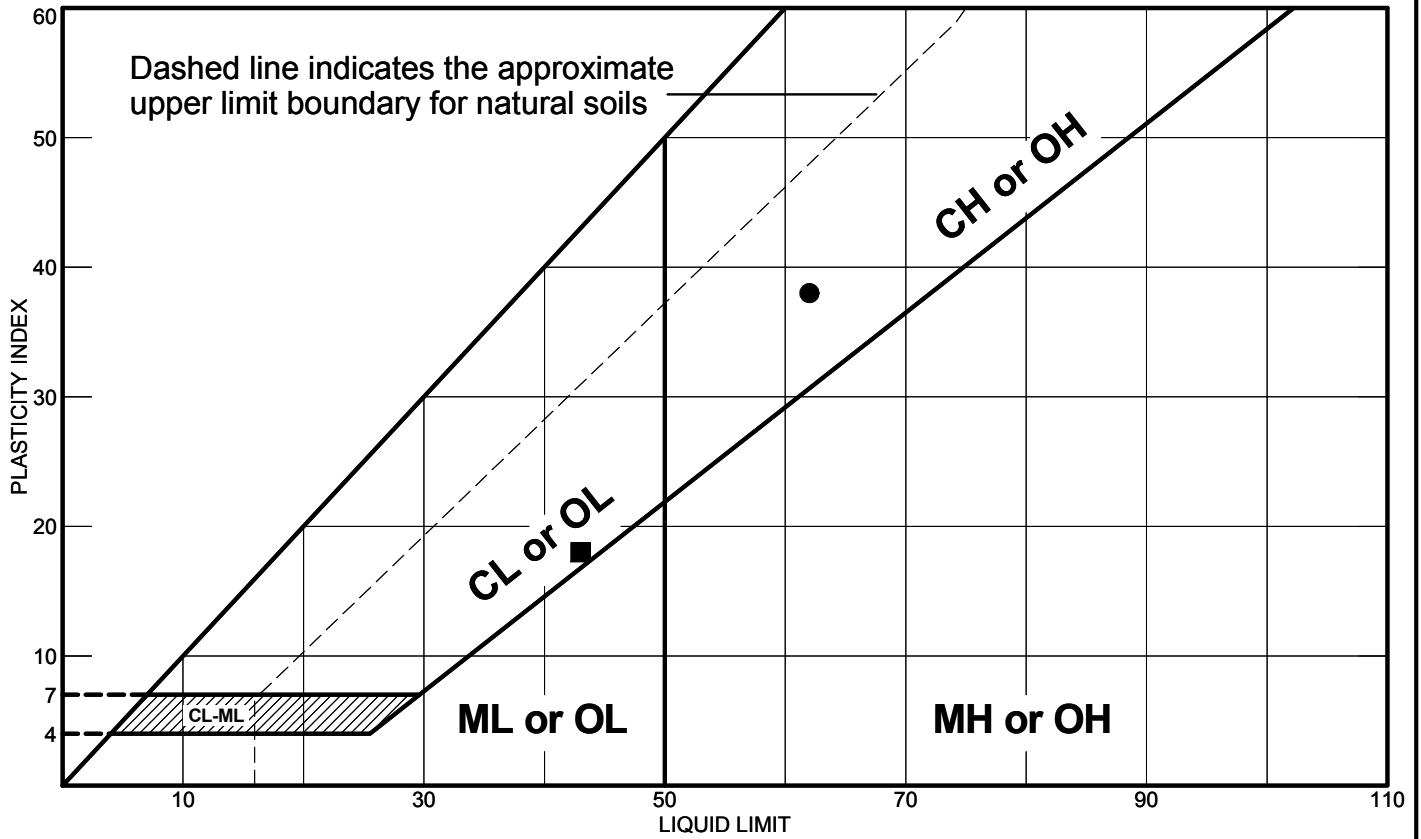

Location + Description	LL	PL	PI	-200	USCS
● Source: HC-4      Sample No.: 7      Depth: 20 Clay	62	24	38		CH
■ Source: HC-4      Sample No.: 11      Depth: 40 Clay	43	25	18		CL

**Remarks:**

- 
- 

**Project:** Mercer Island Center for the Arts

**Client:** Mercer Island Center for the Arts

**Location:** Mercer Island, WA



**HARTCROWSER**

19120-00

2/15

Figure B- 2

# Particle Size Distribution Test Report

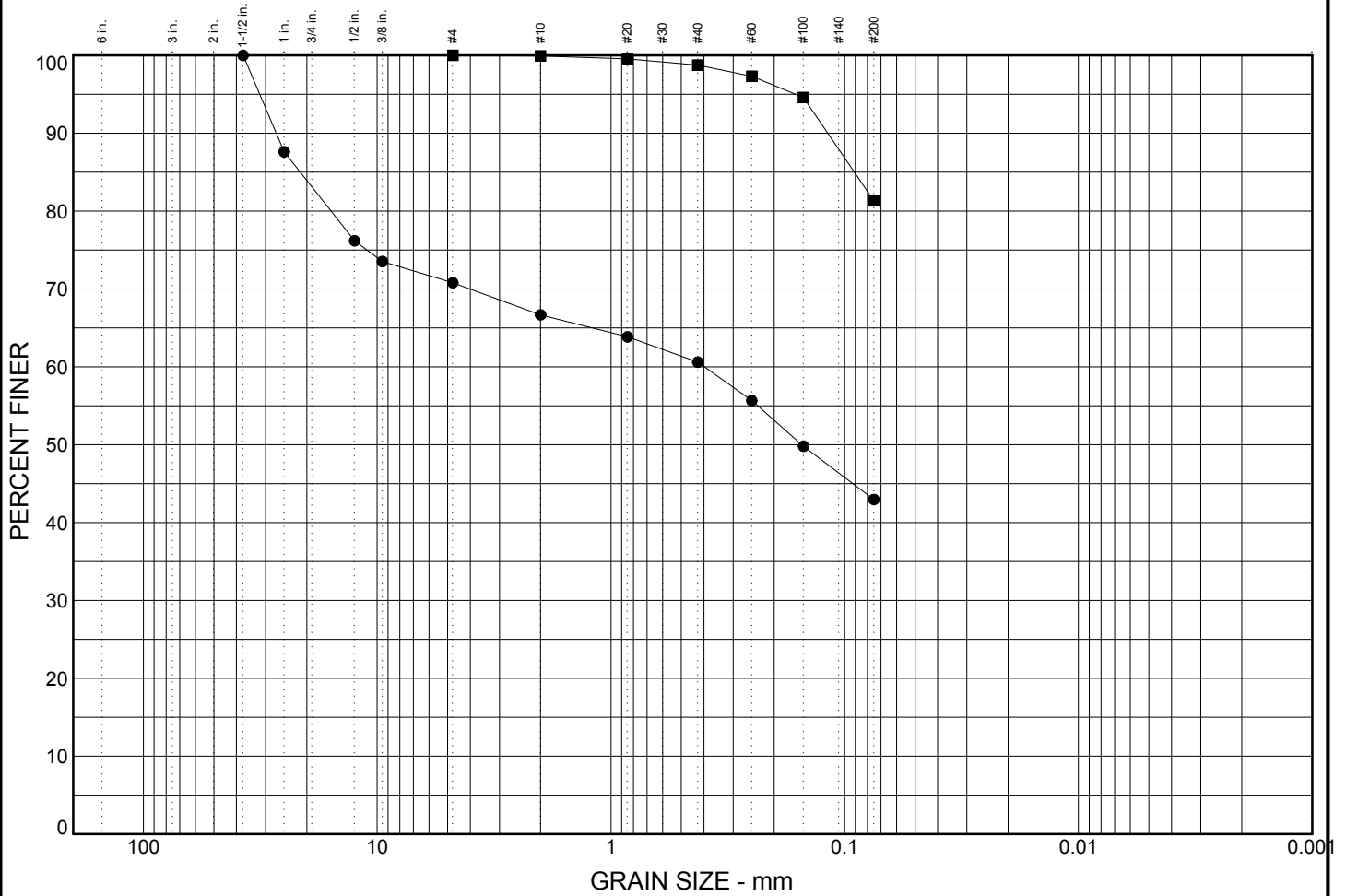

	% COBBLES	% GRAVEL	% SAND	% SILT	% CLAY
●	0.0	29.2	27.8	43.0	
■	0.0	0.0	18.7	81.3	

×	LL	PI	D <sub>85</sub>	D <sub>60</sub>	D <sub>50</sub>	D <sub>30</sub>	D <sub>15</sub>	D <sub>10</sub>	C <sub>c</sub>	C <sub>u</sub>
●			21.324	0.398	0.152					
■			0.091							

MATERIAL DESCRIPTION	USCS	NAT. MOIST.
● sandy clayey GRAVEL	GC	14.8%
■ sandy SILT	ML	27.9%

**Remarks:**

●

■

**Project:** Mercer Island Center for the Arts

**Client:** Mercer Island Center for the Arts

● Source: HC-4      Sample No.: 2      Depth: 2.5 to 4.0

■ Source: HC-4      Sample No.: 4      Depth: 7.5 to 9.0



GRAIN SIZE 1912000-BL.GPJ HC CORP.GDT 3/27/15

APPENDIX **C**  
Historical Explorations



## Historical Explorations

Historical exploration logs are included in this appendix as follows:

Hart Crowser 1980. Design Phase Subsurface Explorations and Geotechnical Engineering Study, Proposed Office Building And Parking Structure for Farmers New World Life Insurance Company, Mercer Island, Washington. January 4, 1980. J-857-01.

Shannon & Wilson 1985. Preliminary Geotechnical Report, Mercer Island Civic Center, Mercer Island, Washington. August, 1985. Partial report accessed from the DNR Subsurface Geology Information System, Document ID 13758, <https://fortress.wa.gov/dnr/geology>.

Logs and test reports by others are included as they were produced by others for reference only and Hart Crowser is not responsible for the accuracy or completeness of the information presented in the logs. Approximate locations of the explorations by others are shown on Figure 2; actual locations may differ from those shown.

Area: Mercer Island

Status:

DocID 13758

Source: City of Mercer Island DSG-Archive

Local ID#: 8978

Local ID#2:

Site Address 3249 78th Ave SE

Date Copied: 11/3/04

By: PTI

- Title page with the following information:
  - Company (Author) name
  - Report date
  - Project Name
  - Company's job number
  - Site address
- Executive Summary / Introduction of the report
- Table of contents
- Project Location Map / Vicinity Map
- Site / Exploration Plans, Boring Location Plans
- Cross-sections / Subsurface profiles
- Exploration Logs
- Monitoring Well Logs
- Cone Penetrometer Logs
- Groundwater Elevation Tables / Data

Includes data from Previous Reports

No new data /data review

Missing Data / Illegible Data

Explanation \_\_\_\_\_  
\_\_\_\_\_  
\_\_\_\_\_

Comments: \_\_\_\_\_

City Hall construction bot 3 of 4  
\_\_\_\_\_  
\_\_\_\_\_

ArcView RW

Layers RW

Checked RW

Checked AF

**Preliminary Geotechnical Report  
Mercer Island Civic Center  
Mercer Island, Washington**

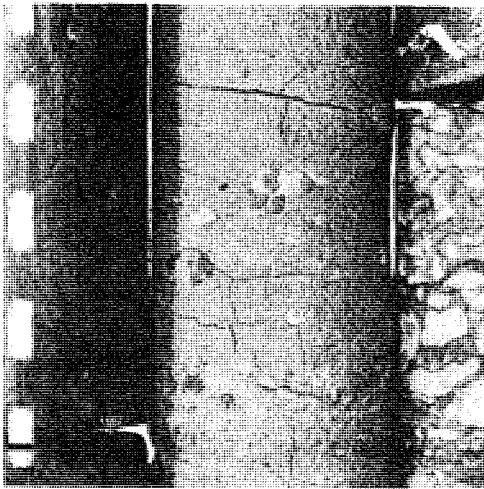

**City of Mercer Island  
3505 88th Avenue S.E.  
Mercer Island, Washington 98040**

**August 1985**

**SHANNON & WILSON, INC.**

**W-4429-01**



SHANNON & WILSON, INC.  
Geotechnical Consultants

JOB NO. W-4429-01    DATE 7-19-85    LOCATION NW CORNER  
PROJECT CITY OF MERCER ISLAND, MERCER ISLAND CIVIC CENTER

LOG OF TEST PIT TP-1

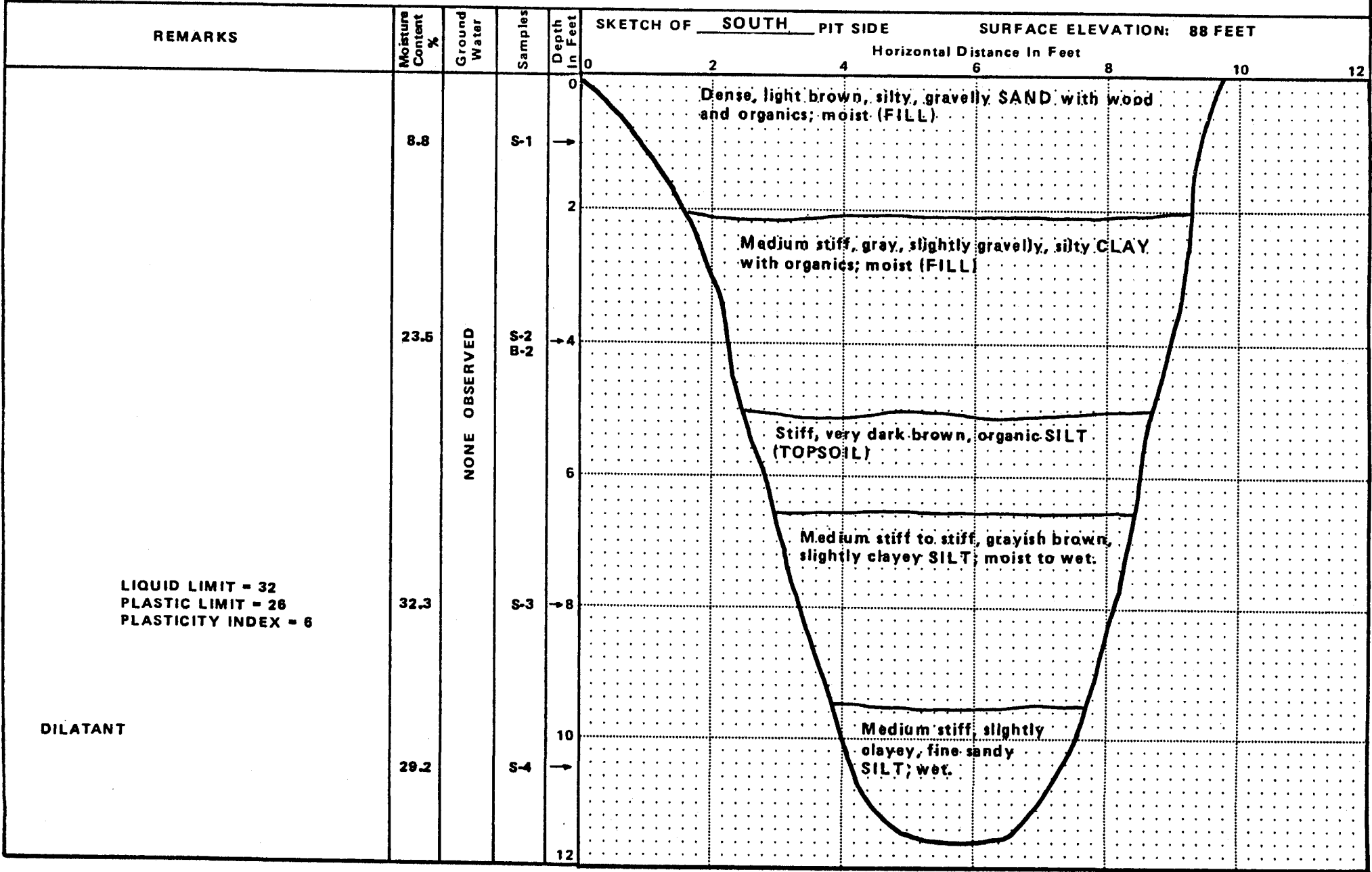

LIQUID LIMIT = 32  
PLASTIC LIMIT = 26  
PLASTICITY INDEX = 6

DILATANT

FIG. A-6

DESIGN PHASE SUBSURFACE EXPLORATIONS AND GEOTECHNICAL  
ENGINEERING STUDY

PROPOSED OFFICE BUILDING AND PARKING STRUCTURE FOR  
FARMERS NEW WORLD LIFE INSURANCE COMPANY

MERCER ISLAND, WASHINGTON

J-857-01



# BORING LOG B-5

## STANDARD PENETRATION RESISTANCE

(140 pound weight, 30 inch drop)

BLOWS PER FOOT ▲

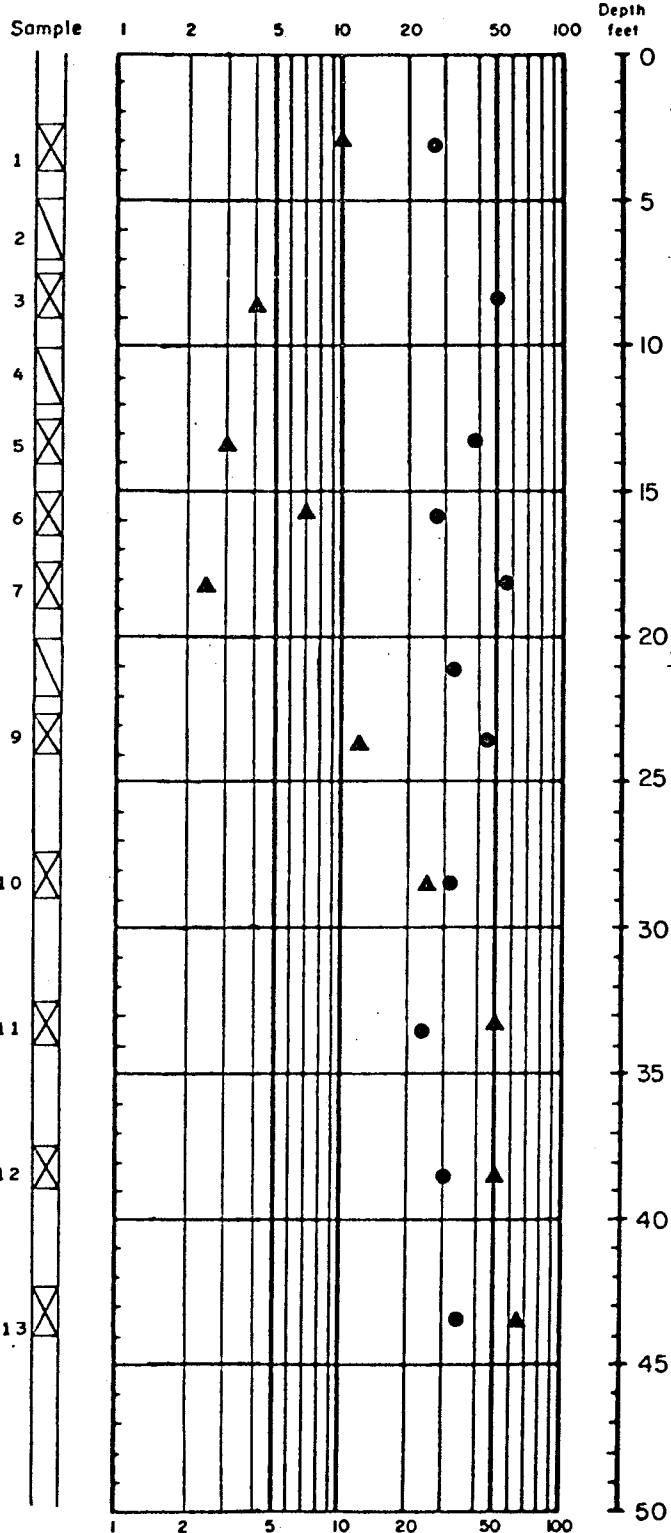

WATER CONTENT PERCENT ●

## SOIL INTERPRETATION

GROUND SURFACE ELEVATION APPROXIMATELY 83 FEET.

POST GLACIAL LUCISTRINE SEDIMENTS:  
MEDIUM TO STIFF, MOIST, BROWN AND TAN, SILTY CLAY AND CLAYEY SILT, OCCASIONAL FINE SAND, LAMINATED. WEATHERED.

SOFT TO STIFF, MOIST, GRAY, SILTY CLAY AND CLAYEY SILT. LAMINATED.

— SAND PARTINGS

GLACIALLY CONSOLIDATED SEDIMENTS:

VERY STIFF TO HARD, MOIST, GRAY, SILTY CLAY AND CLAYEY SILT.

— OCCASIONAL GRAVEL

— WITH SOME SAND AND GRAVEL.

— LAMINATED

BOTTOM OF BORING 44 FEET.  
COMPLETED 11/19/79.

### LEGEND

- ⊗ 2" O.D. Split Spoon Sample
- ⊠ 3" O.D. Shelby Sample
- \* No Sample Recovery
- ▽ Water Level
- Observation Well

NOTE: Soil descriptions are interpretive and actual changes may be gradual.

J-857-01 December 1979

HART-CROWSER & associates inc.

Figure A-9